

Part # AXE-6-963

CorkSport
MAZDA PERFORMANCE

CorkSport Mazdaspeed 3 Adjustable Shifter

2007- 2009 Mazdaspeed 3



The **CorkSport Adjustable Short Shifter** is designed as a direct OEM replacement, maintains OEM fitment and allows you to independently adjust shift throw distance and shift knob height. Designed to easily replace the OEM design with a durable machined aluminum body to handle a variety of shifting styles from the casual to aggressive driver. Please let us know your feedback of the CorkSport Mazdaspeed 3 adjustable Shifter by submitting a review at: <https://corksport.com/2007-2009-mazdaspeed-3-short-shifter.html>

Pre-Installation Notes:



Read through these instructions before starting installation. Section 8 covers shifter operation and adjustment procedures.



Make sure your clothes, tools and hands are clean while working on the interior of your car.



These instructions were written for reference only and the use of a factory service manual is recommended.



How our instructions work: To best cover all of our customers experience levels, we have included a table of contents/order of operations along with step-by-step instructions.



These in car installation photos were produced using a 2009 Mazdaspeed 3. 2007-2008 Mazdaspeed 3 will be similar.

Materials and Time:



General Info.

Part #: AXE-6-963-10
Time Est: 1 hours
Wrench Rating: 3/5



Tooling List

5mm Allen Wrench
10mm Wrench
3/8" Ratchet Wrench
Long 3/8" Socket Extension
T-20 Torx Screwdriver
Door Panel Removal Tool (or two Large Flat Head Screw Drivers)
Three small picks (or small screwdrivers)
White Lithium Grease









Parts List

One (1) Adjustable Short Shifter
One (1) M6x10mm Ball Stud

Need Help With Your Installation?
Call (360) 260-CORK

Order of Operations & Table of Contents

 Interior Disassembly Section 1: Remove the Interior Panels	Pg. 2
 Shifter Assembly Removal Section 2: Remove the OEM Shifter Assembly	Pg. 3-4
 CorkSport Short Shifter Install Section 3: Shifter Assembly Components Description Section 4: Remove OEM Shifter from Housing Section 5: Install the CorkSport Short Shifter into the Shifter Housing	Pg. 5 Pg. 6-7 Pg. 8
 Shifter Assembly Installation Section 6: Reinstall the Shifter Assembly	Pg. 9
 Interior Assembly Section 7: Reinstall the center console panels and shift knob	Pg. 9
 Adjusting the CorkSport Short Shifter Section 8: How to adjust the short shifter	Pg. 10

Detailed Instructions

1. Remove the Interior Panels

- a) Remove the shift knob by firmly twisting it counter-clockwise (Figure 1a).



Figure 1a

- b) Remove the cup holder panel by pulling up on the rearward end inside the center console (Figure 1b). Then rotate it forward over the parking brake.



Figure 1b

- c) Remove the shifter panel by pulling up on the rearward end inside the center console (Figure 1c).



Figure 1c

2. Remove the OEM Shifter Assembly

a) Use a door panel removal tool to pry the shift cable ends off the shifter ball studs (Figure 2a).



Door panel tool may be substituted by using two large flat head screw drivers.

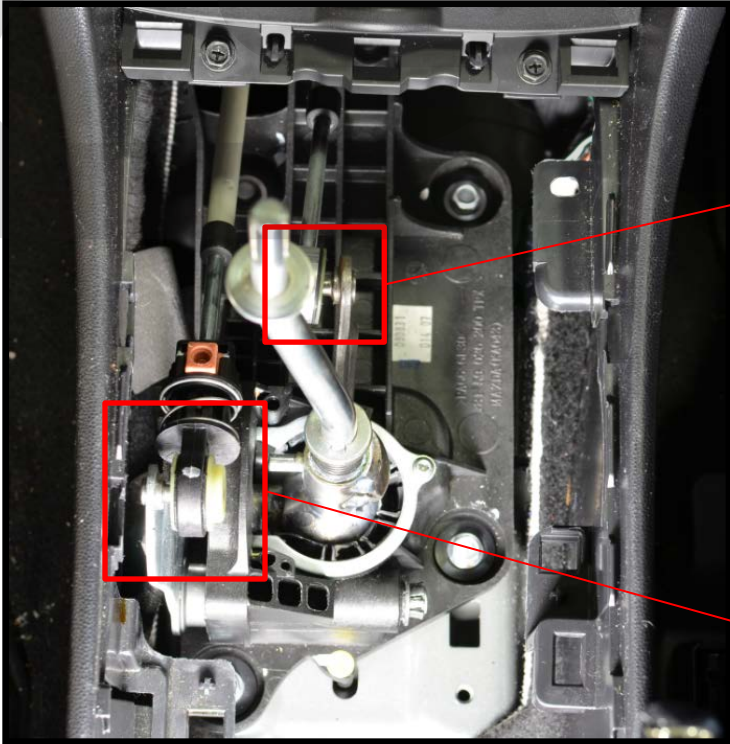

Figure 2a



b) Remove the shifter cables from the shifter housing. Use a large flat head screwdriver to pop the cable clip loose. Place the flathead end under the clip, then pry up while twisting the screwdriver. (Figure 2b & 2c)

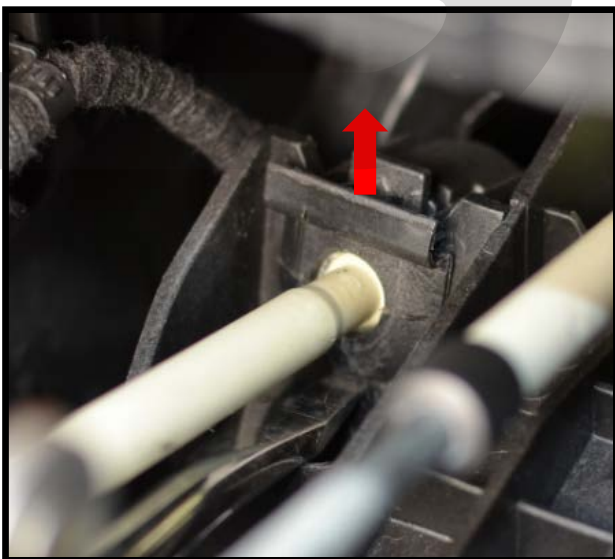

Figure 2b

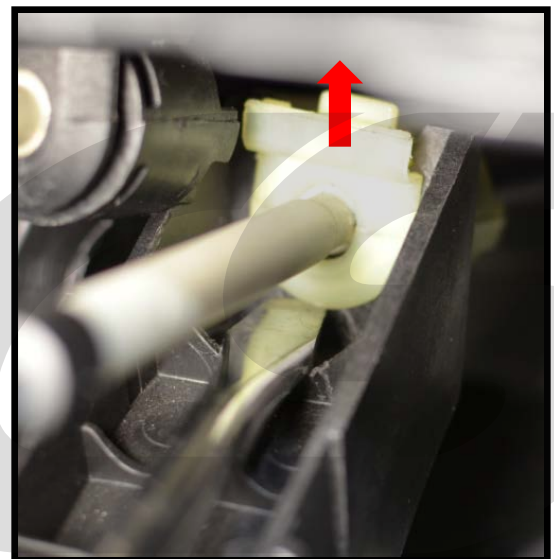

Figure 2c

2. Remove the OEM Shifter Assembly (continued)

- c) **Move the shifter cables out of the way.** Move the driver's side cable to the left and move the passenger side cable to the right (**Figure 2d**)

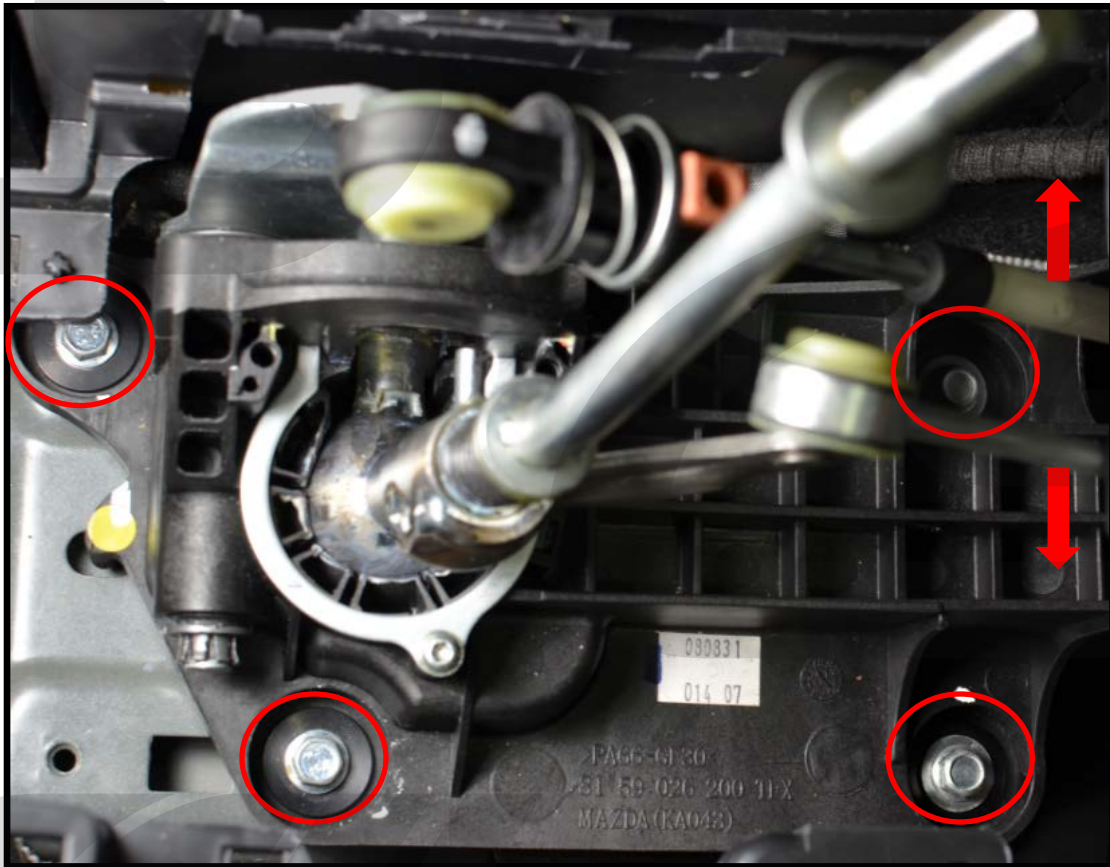

Figure 2d

- d) **Remove the shifter assembly from the car** using a 10mm socket, long extension and ratchet wrench (**red circles** in **Figure 2d**).



If you have aftermarket shifter bushings be careful to not knock one of the lower bushings to the side where it can be lost.

- e) **Lift the shifter assembly out of the center console.**

3. Shifter Assembly Components Description

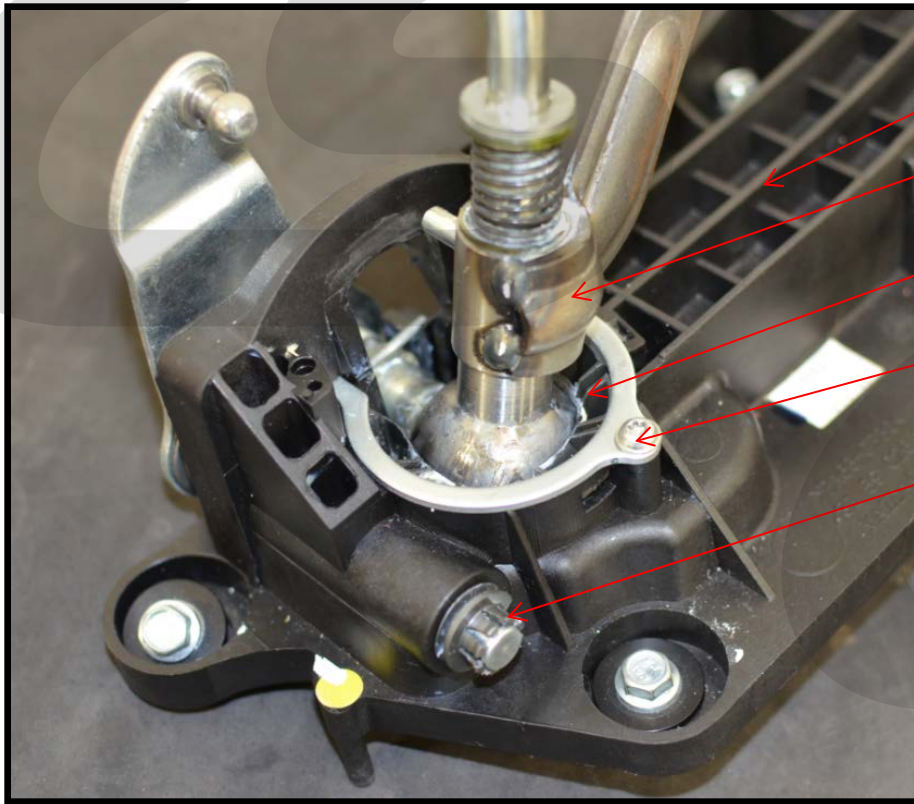

Figure 3a

Shifter Housing

OEM Shifter

Shifter Cup

Metal Retaining Ring
w/T-20 Torx Screw

Plastic Retainer Clip

Side Action Actuator

Ball Stud Plastic Cap

Side Action Spring

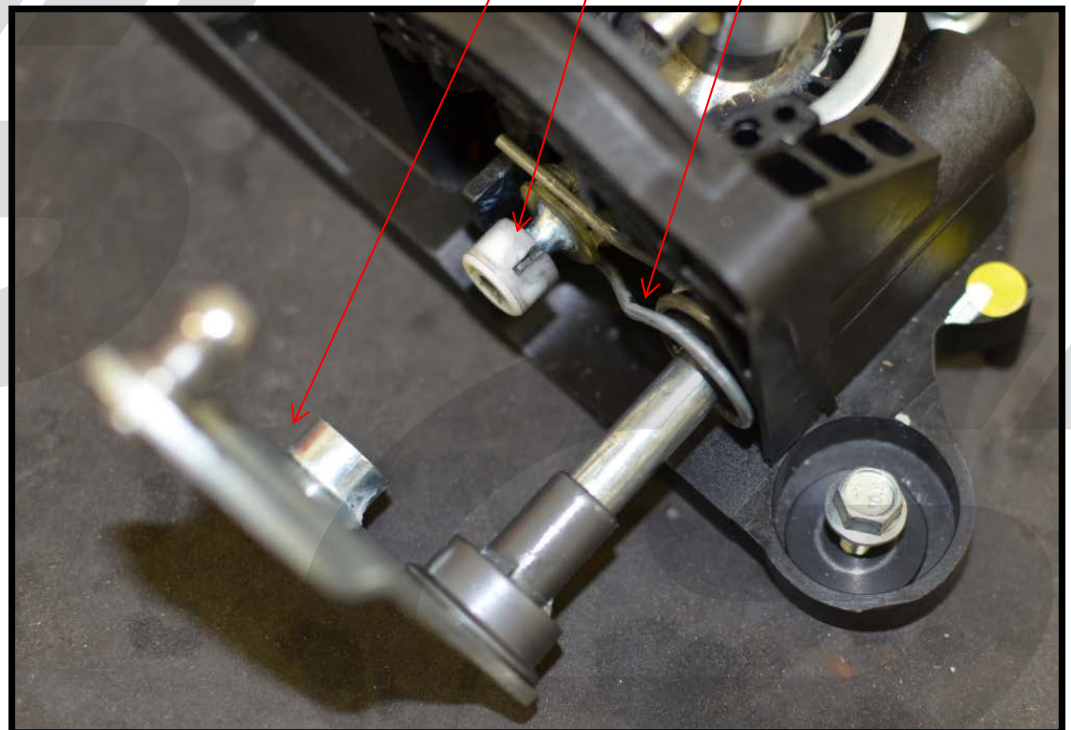

Figure 3b

4. Remove OEM Shifter from Housing

- a) Remove the plastic retaining clip. Use a small pick to pop the fingers loose. (Figure 4a) Then use a flathead screwdriver to pop the whole clip off the rod.



Do not break the tabs off of the clip. You will re-use the clip and they cannot be purchased separately from the entire shifting mechanism.

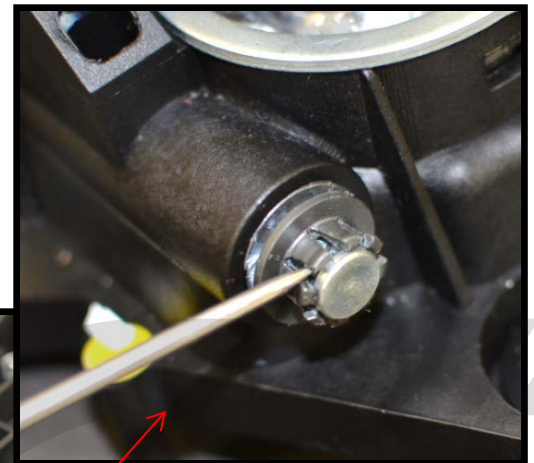
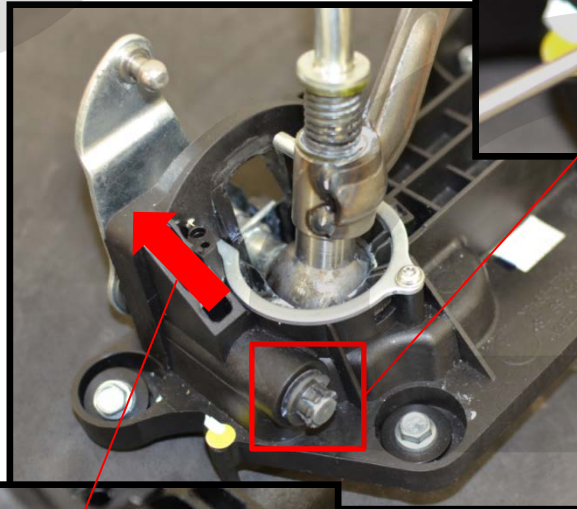

Figure 4a



- b) Remove the side actuator arm. With the plastic retaining clip removed, slide the side actuator arm out of the shifter housing (Figure 4b)



Note the orientation of the tabs on the collar, these will need to align with slots for reassembly.

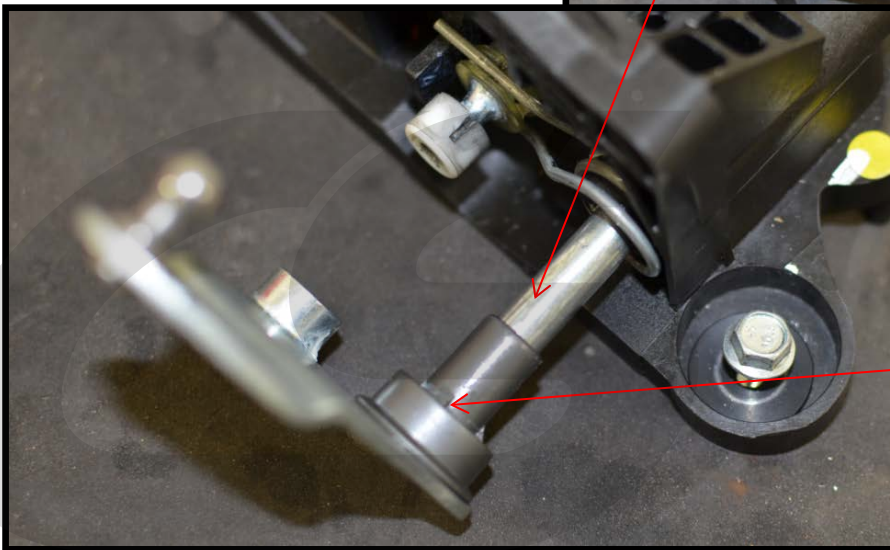

Figure 4b

- c) Remove the metal retaining ring.. Use a T-20 Torx to remove the screw and metal ring. (Figure 4c)



Figure 4c

4. Remove OEM Shifter from Housing (continued)

d) **Remove the side action spring.** Use a large pick or screwdriver to remove the spring (Figure 4d).

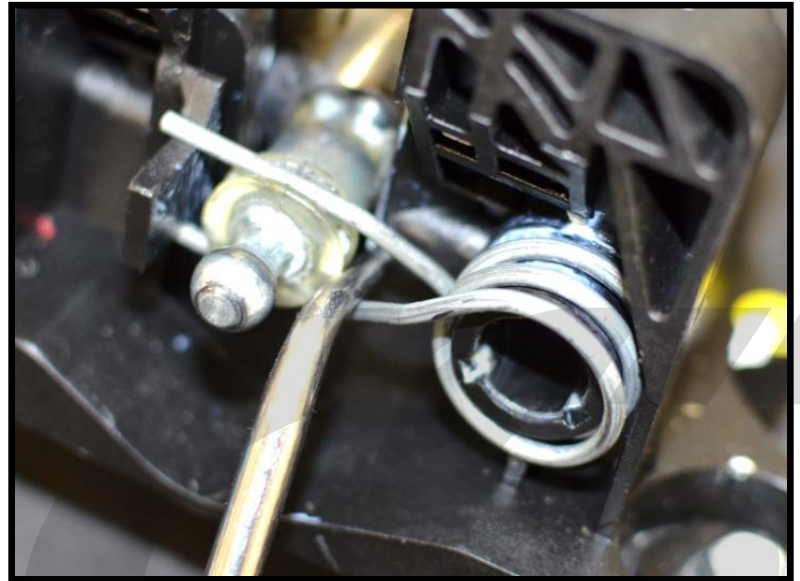

Figure 4d

e) **Locate the tabs in the shifter cup.** There are two openings circled in red in Figure 4e to access two of the cup tabs. The three tabs are shown with red arrows in Figure 4f.



An extra set of hands may be useful

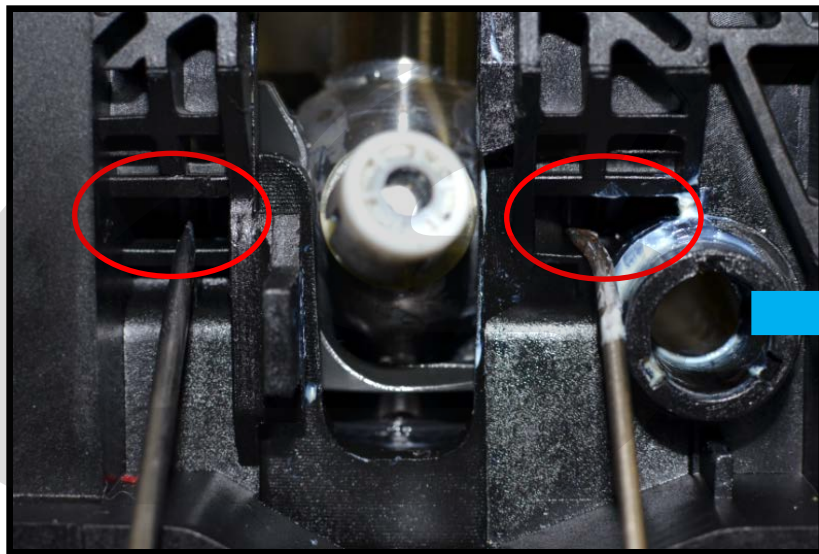

Figure 4e



Figure 4f

f) **Remove the shifter and shifter cup.** Use three small screwdrivers or picks to pop the cup out of the housing.

5. Install the CorkSport Short Shifter into the Shifter Housing

- a) Lubricate the CorkSport shifter with the lithium grease. Put grease where the shifter cup and plastic ball stud cap will go.
- b) Remove the ball stud cap, shifter cup and o-ring from the OEM shifter. Then put these components on the CorkSport shifter. (Figure 5a)



Figure 5a

- c) Place the CorkSport shifter with components into the shifter housing.
- d) Mount the side action spring. Place the spring around the collar and position one of the spring arms in the groove of the shifter side action arm, shown in Figure 5b. Using a screwdriver or large pick, pull the other spring arm around and down below the shifter side action arm, shown in Figure 5c. Using your other hand to hold the spring around the collar.

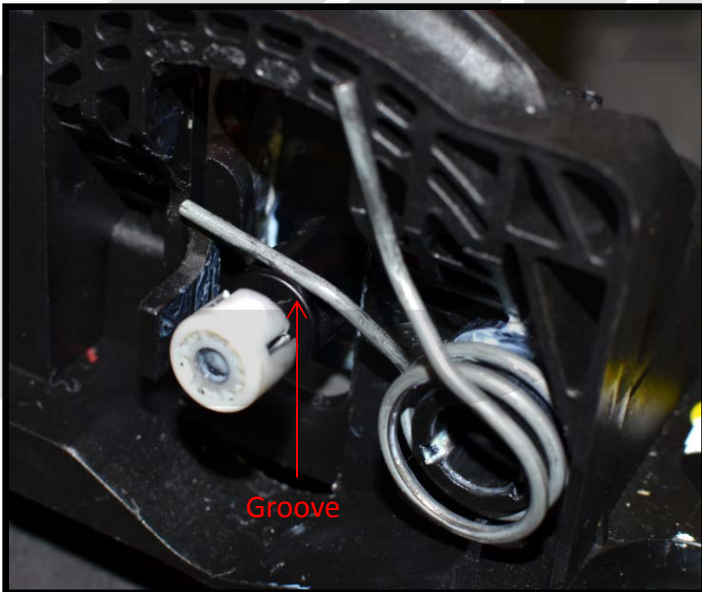

Figure 5b

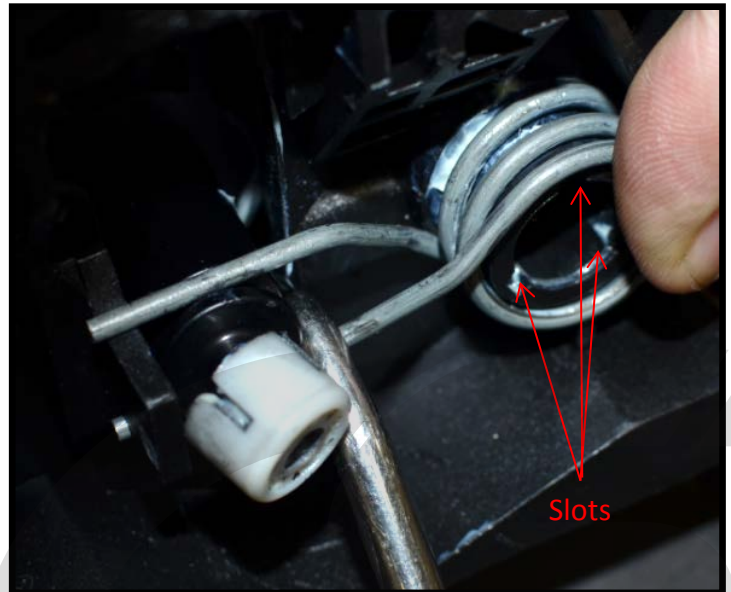

Figure 5c

- e) Reinstall the side action actuator. Slide the actuator into the housing and over the ball stud cap. Then install the plastic retaining clip.
- f) Reinstall the metal retaining ring using the T-20 Torx.

6. Reinstall the Shifter Assembly



If you have aftermarket shifter bushings be careful to not knock one of the lower bushings to the side where it can be lost.

- a) **Place the shifter assembly into the center console.** Use a 10mm socket, long extension, and ratchet wrench to tighten the four 10mm bolts.
- b) **Put the shifter cables into there slots and snap them into place.** Verify that they are tight and cannot come loose.
- c) **Put a small amount of lithium grease on the ball studs,** then snap the shifter cable ends onto the ball studs.

7. Interior Assembly

- a) **Install the shifter panel, then the cup holder panel.**
- b) **Install the shift knob.**



This completes the installation of your CorkSport Adjustable Short Shifter. Refer to the next page for adjustment instructions. Check for proper engagement in all gears before operating the vehicle on the road. Most importantly, enjoy!



CorkSport does NOT recommend using a short shifter plate and in-cab short shifter simultaneously. This combination may cause too much stress on components and provide insufficient driver feedback.

8. Adjusting the CorkSport Adjustable Shifter

The Corksport machined shifter adjusts in two different ways; shifter height and throw; both of which are adjustable in the car!

Throw is the amount of distance the shifter needs to move to change gears. In the Mazda platform with cable shifting only the fore/aft movement of the throw is adjustable i.e. From first 1st–2nd, 3-4th, and 5-6th.

Note: The shorter the throw is adjusted, the more force you have to apply to shift gears.

To adjust throw move the ball stud upward the row of holes to shorten the shifter throw, and downward to lengthen throw. With the shifter installed in the car, use a 10mm wrench to loosen and tighten the ball stud (Figure 8a).

Note: Not all holes in all rows will work well for all cars. After adjusting the throw test the setting by running through ALL gears and make sure they engage fully.

To adjust height, loosen the two (2) 5mm hex screws on the adjustment body, and slide the shaft upward or downward. Lock the collar in place by evenly tightening the two 5mm hex screws. Downward adjustment is limited to the top notch in the shaft. Upward adjustment is limited to the bottom notch on the shaft. (Figure 8b) For max and min shift knob height, align the notch with the top of the adjustment body.

Note: Lowering the shifter will decrease the amount of leverage to engage gear thus shifting will require more force.

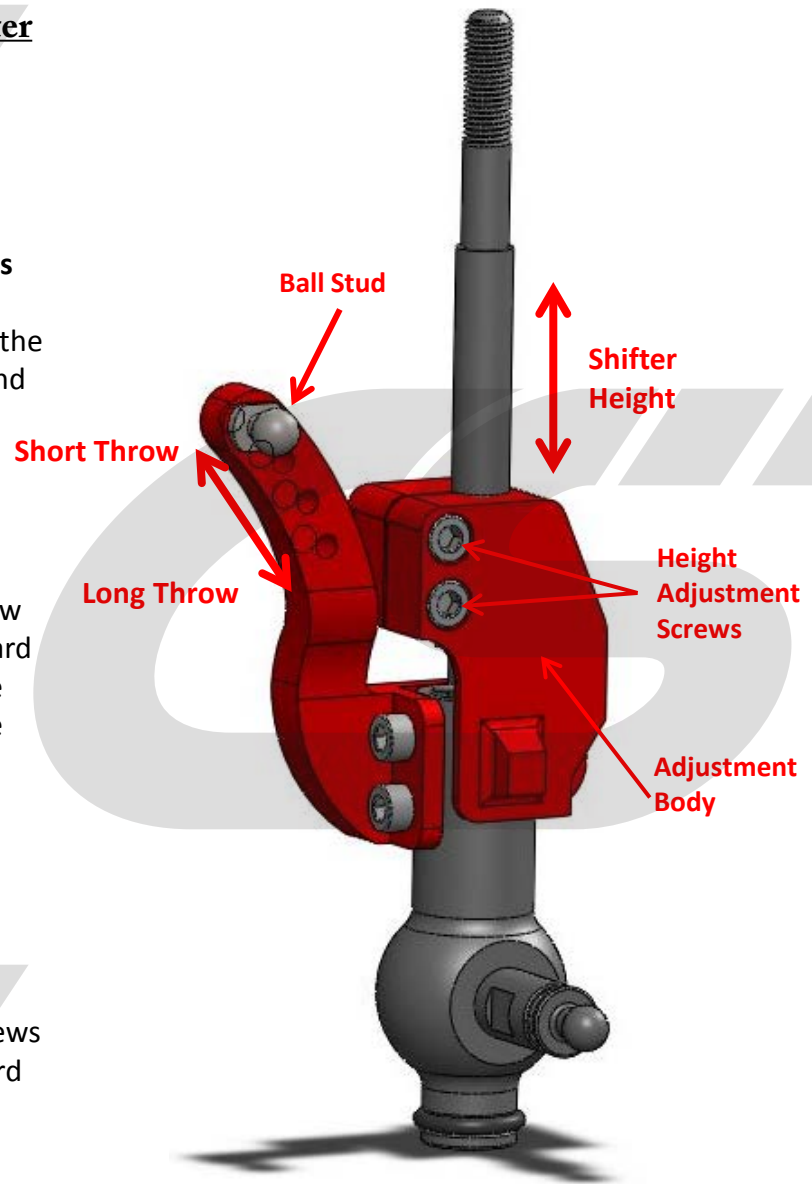

Figure 8a



Once desired adjustment is achieved, it is recommended to lock tight the ball stud to prevent loosening during use.

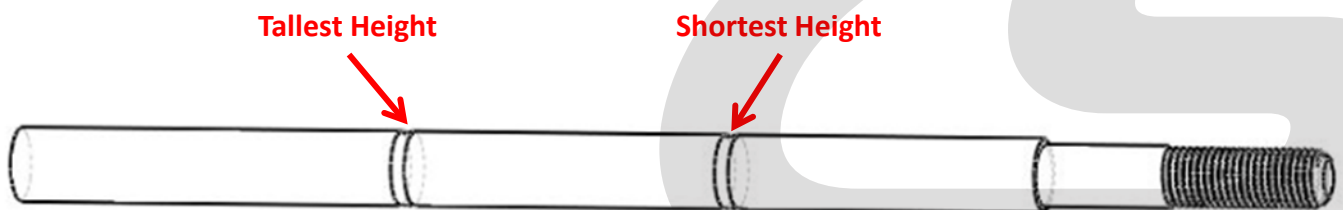

Figure 8b

What's Next:



CorkSport Intake Systems

One of the easiest and most beneficial performance enhancements you can do for your vehicle, the CorkSport Intake systems replaces your factory air box with an open intake system allowing more air into the intake chamber. Available for the Mazda 3 & Mazdaspeed 3 models.

CorkSport Mazda & Mazdaspeed 3 Lowering Spring Set

Give your car the performance appearance and edge you have been looking for with the CorkSport Lowering Springs. The CorkSport Lowering Springs to your Mazda 3 will result in a quicker turning response, crisper road feel, a more aggressive appearance, and a firmer spring rate, while maintaining excellent ride quality. The CorkSport Mazdaspeed 3 Lowering Springs have an average increased spring rate of 25%



CORKSPORT 2007-2009 Mazda 3/Mazdaspeed 3 License Plate Kit



Give your 2007-2009 Mazdaspeed 3 a visual boost and improve airflow with the CorkSport License Plate Relocation Kit. By offsetting your factory license plate and moving it to the drivers side, the CorkSport license plate relocation kit will allow for better airflow and improve the overall look of your 2007-2009 Mazdaspeed 3.