

CorkSport Performance

AXO-3-303 Camber Plates

Installation Instructions for the CorkSport Performance Camber plates for the 2019+ Mazda 3 and 2020+ Mazda CX-30.

Written By: Cody Dunton



INTRODUCTION

In this installation guide we have provided step by step instructions to remove the OEM Front Strut Top and install the CorkSport Performance Camber Plates.

Advisory:

- Working under the vehicle requires a safe and sturdy location for the vehicle to sit on jackstands.
- Spring compressors can be dangerous. Follow the manufacturer's instructions and safety precautions to prevent injury.

 **TOOLS:**

- Hydraulic Jack (1)
- Jack Stand (2)
- Spring Compressors (2)
- 3/8" Drive Ratchet (1)
- 1/2" Drive Breaker Bar (1)
- 1/2" Torque Wrench (1)
- 1/2" Impact Gun (if available) (1)
- 3/8" Drive Electric Impact Gun (1)
- 10mm Socket - Deep (1)
- 12mm Socket - Deep (1)
- 14mm Socket - Deep (1)
- 17mm Socket - Deep (1)
- 21mm Socket - Deep (1)
- 5mm Ball End Allen Key Socket (1)
- 6mm Allen Key Socket (1)
- Wrench, 14mm (1)
- Wrench, 17mm (1)
- Wrench, 19mm (1)
- Small Needle Nose Pliers (1)
- Flathead Screwdriver (1)
- WD-40 Lubricant Spray (1)
- Shop Towels/Rags (1)
- Small Sledge Hammer (1)
- Safety Glasses (1)
- Gloves (1)

 **PARTS:**

- AXO-3-303 Camber Plate (2)

Step 1 — Getting Started



- First and foremost; **THANK YOU** for becoming a part of the CorkSport Family. We hope to bring you the highest level of Parts, Customer Service, & Support
- ⓘ How To Use These Instructions
 - The instruction format will relate colored marking in the image to the color dot in the text to the right of the image
- ⓘ The vehicle used in these instructions was a 2020 Mazda 3 FWD Hatch. Other model years and configurations will be similar

Step 2 — Lifting the Car & Removing the Front Wheel



⚠ Ensure the vehicle is parked on a level surface before proceeding.

- Start by lifting up the front of the car using the hydraulic jack and jack stands.

⚠ Be sure to reference your owners manual for jack points and the jack manufacturer's instructions for proper practices.

- Remove the left side front wheel from the vehicle using the 1/2" drive breaker bar or impact gun and 17mm or 21mm socket.

i 17mm or 21mm lug nuts present depending on year and trim level of your 3.

i A different socket may be required if you have aftermarket or locking lug nuts.

Step 3 — Front Suspension Component Identification

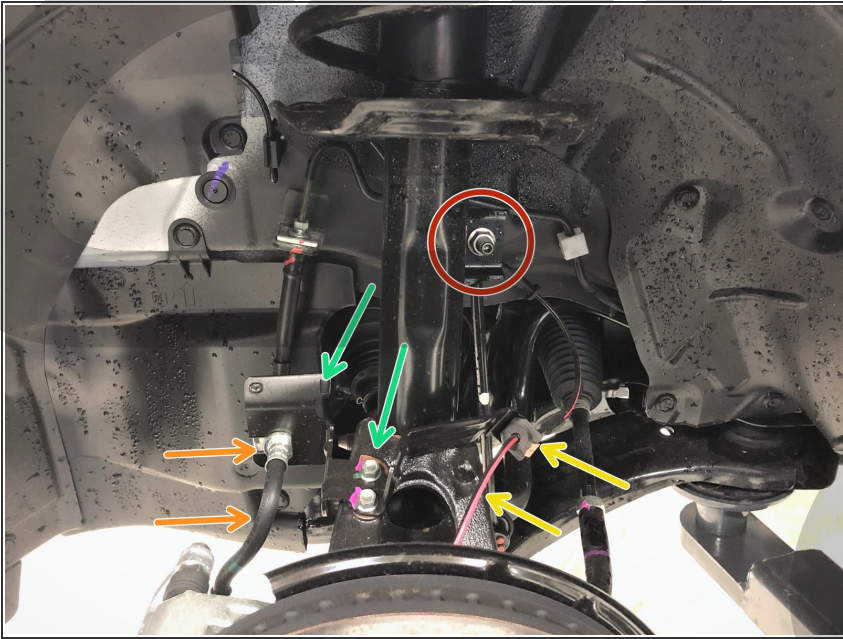

- This image serves as a location reference for components referenced in the following steps.
- Front swaybar endlink
- Front brake line
- ABS wiring
- Front brake line and ABS wiring bracket

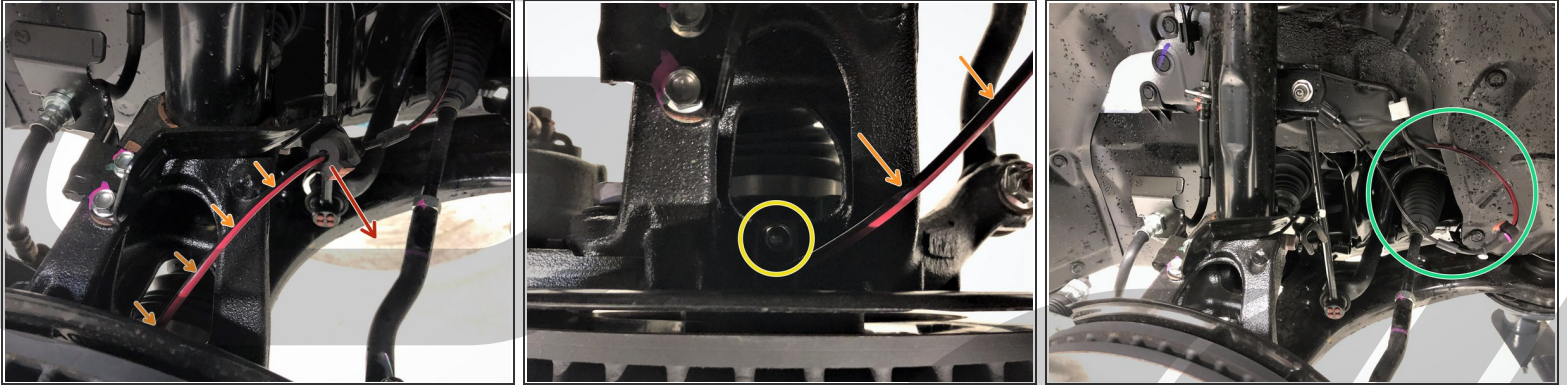
Step 4 — Front Suspension Disassembly - Part 1

- Locate the ABS wiring.
- Pull the ABS wiring free from the mounting bracket by pulling the rubber grommet in the direction shown.
- Trace the ABS wiring to where the sensor is attached to the knuckle near the back of the brake rotor.
- Using a 10mm socket and ratchet, remove the ABS sensor. Pull it free from the knuckle.
- Move the ABS wiring out of the way as shown.

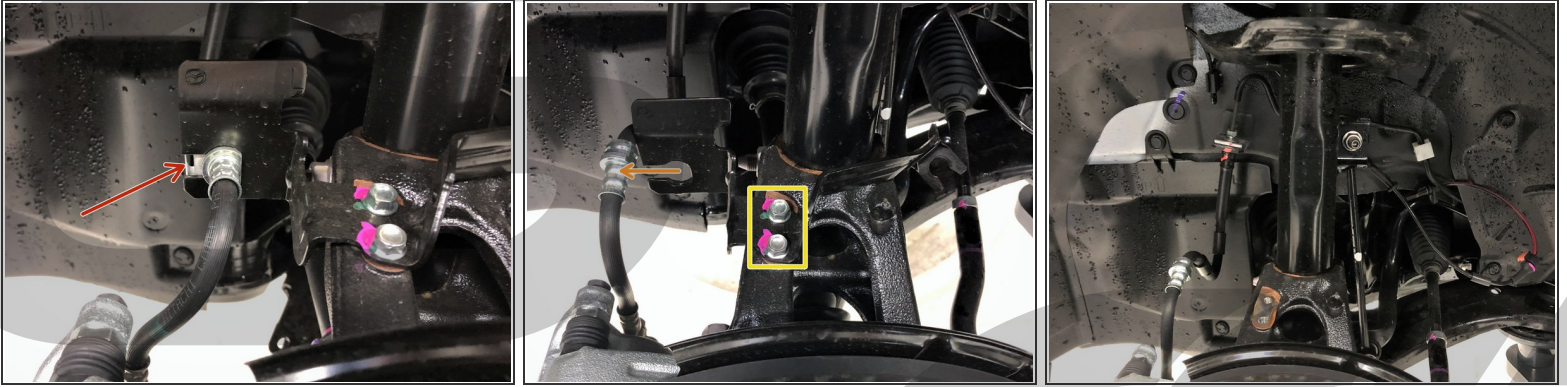
Step 5 — Front Suspension Disassembly - Part 2

- Locate the front brake line.
- Using needle nose pliers or flathead screwdriver, remove the silver brake line retainer clip.
- Then free the front brake line from the mounting bracket.
- Locate the front brake line and ABS wiring bracket.
- Remove the front brake line & ABS wiring bracket by removing the two 10mm bolts.

Step 6 — Front Suspension Disassembly - Part 3

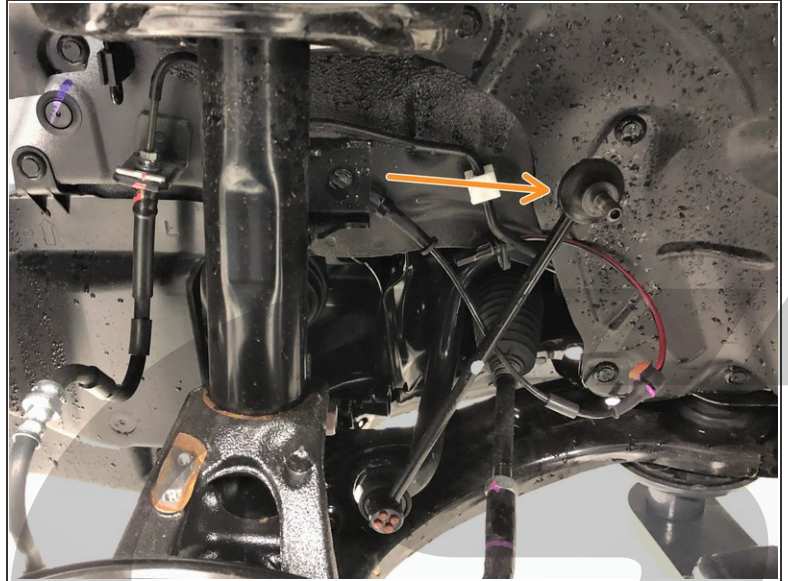
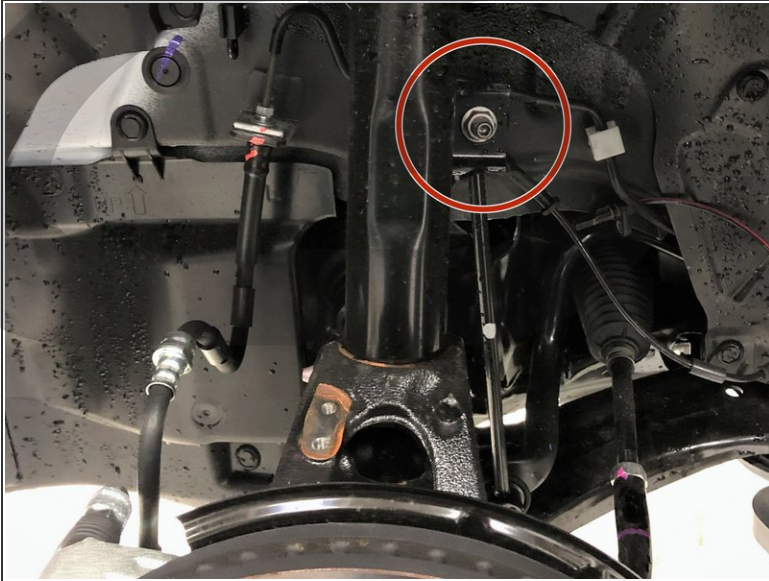

- Locate the front sway bar end link.
- Using a 14mm socket and ratchet, remove the front swaybar end link nut
- ⓘ If the nut is spinning without loosening, use a 5mm Allen key in the center to keep it secure and a 14mm wrench to loosen.
- Push the front swaybar endlink out of the mounting point on the strut and out of the way.

Step 7 — Front Suspension Disassembly - Part 4

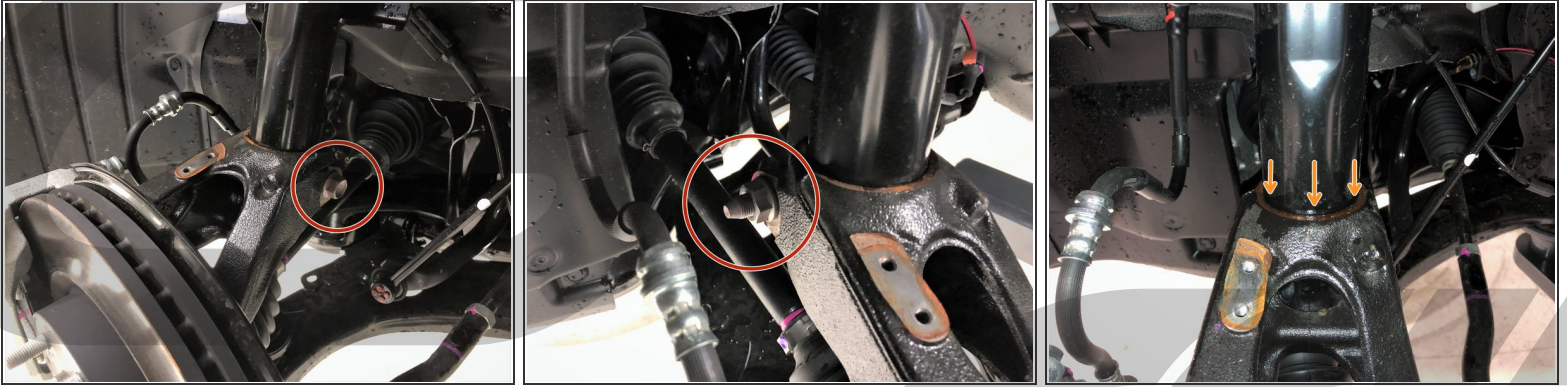

- Locate the strut pinch bolt near the bottom of the front strut.
- Using a 17mm socket and ratchet on the head of the bolt and 19mm wrench on the nut, remove the strut pinch bolt.
- Using WD-40 or a penetrating fluid, lubricate where the strut meets the knuckle.
 - ⓘ Letting the WD-40 sit for a few minutes can help the knuckle release the strut.

Step 8 — Front Suspension Disassembly - Part 5



- Push the knuckle downwards to free the bottom portion of the strut.
- If the knuckle is not moving, use a hammer to hit the knuckle in the location shown.
⚠ If using a hammer use extreme caution to not hit anywhere except where shown or damage may occur.
- The knuckle will need to travel downwards about 3 inches. The second image shows the strut nearly free.
- When the strut is free from the knuckle, the knuckle will likely rotate forward as shown in the third image.

Step 9 — Front Suspension Disassembly - Part 6

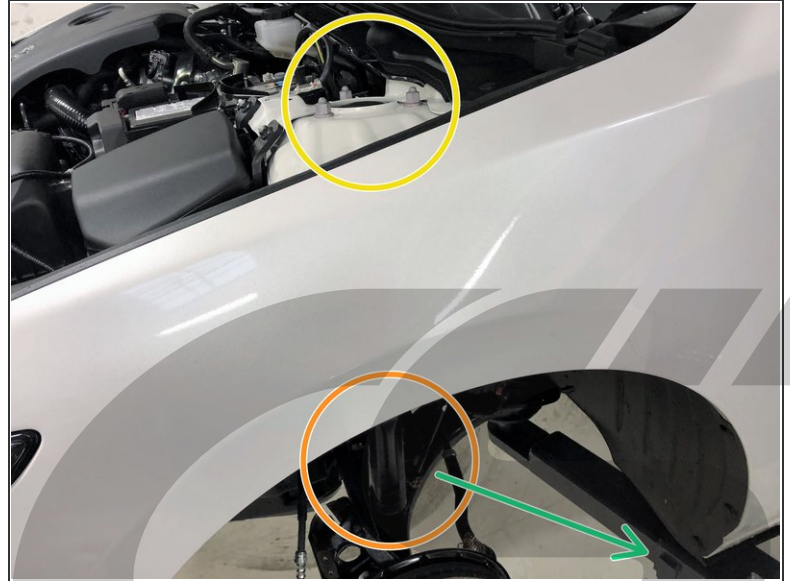
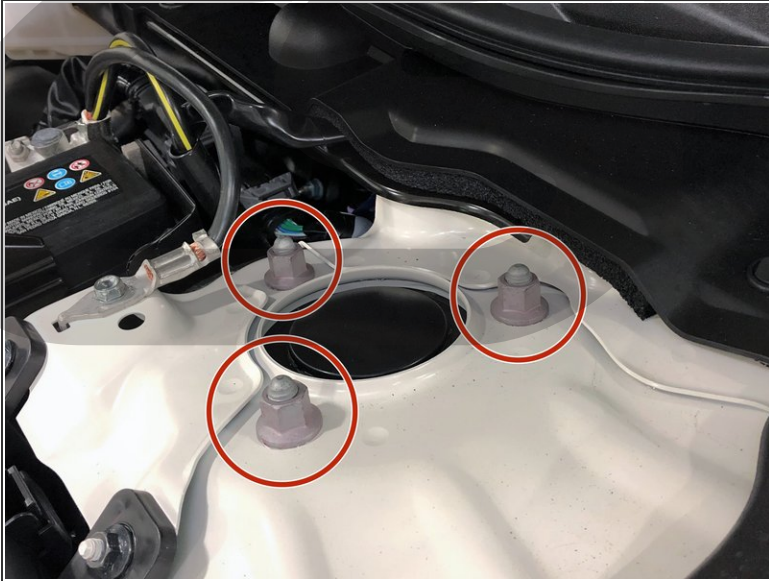

- Open the hood of your vehicle.
- Locate the three nuts holding the front strut to your vehicle. They will be near the back corner of the engine bay.
- Loosen these three nuts with a 14mm socket and ratchet.
- Hold the bottom of the strut with one hand so it does not fall during the next step.
- Completely remove the nuts with the other hand.
- Remove the front strut from the vehicle

Step 10 — Front Strut Disassembly - Part 1



- A strut with a CS lowering spring already installed is shown but the process will be the similar if you are on stock springs.
 - Remove the black plastic cap from the top of the strut. It should pull straight off.
 - Ready your spring compressors. The first image shows a standalone unit that makes compressing springs easier if done frequently.
 - The second image shows more traditional spring compressors.
- ⚠ Spring compressors can be very dangerous if used improperly. Ensure you understand how to use them and are following the manufacturer's recommended practices.
- ⚠ Use personal safety equipment when using a spring compressor - safety glasses & gloves for example

Step 11 — Front Strut Disassembly - Part 2



- Compress the spring until the top spring coil is no longer touching the spring top hat.
- Remove the 17mm nut on top of the strut using a 17mm wrench and a 6mm Allen key or socket.
- ⓘ If you have an impact gun, you can also use it to remove the strut top nut. Be sure to turn your air pressure down to 60-80psi to prevent damage to the strut.
- ⓘ You may need a pass-through socket to remove the nut depending on the tools you have available.

Step 12 — Front Strut Disassembly - Part 3

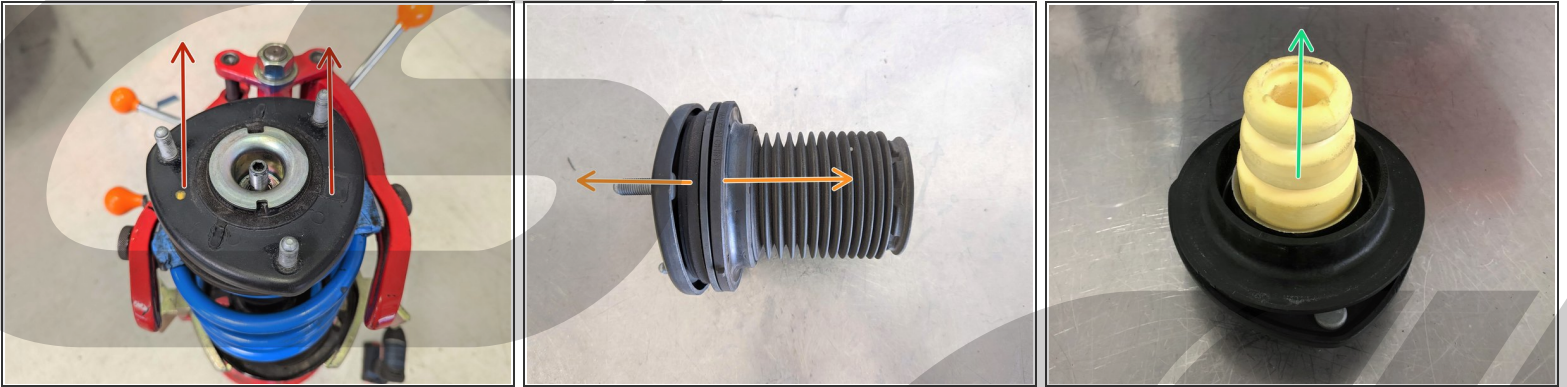

- Remove the strut top hat.
- Separate the dust boot from the spring top hat.
- Pull the bump stop free from the spring top hat if you have stock springs installed.
- ⓘ If you already have CS lowering springs the bump stop will already be removed and is still on the strut.

Step 13 — Separating the OEM Strut Top

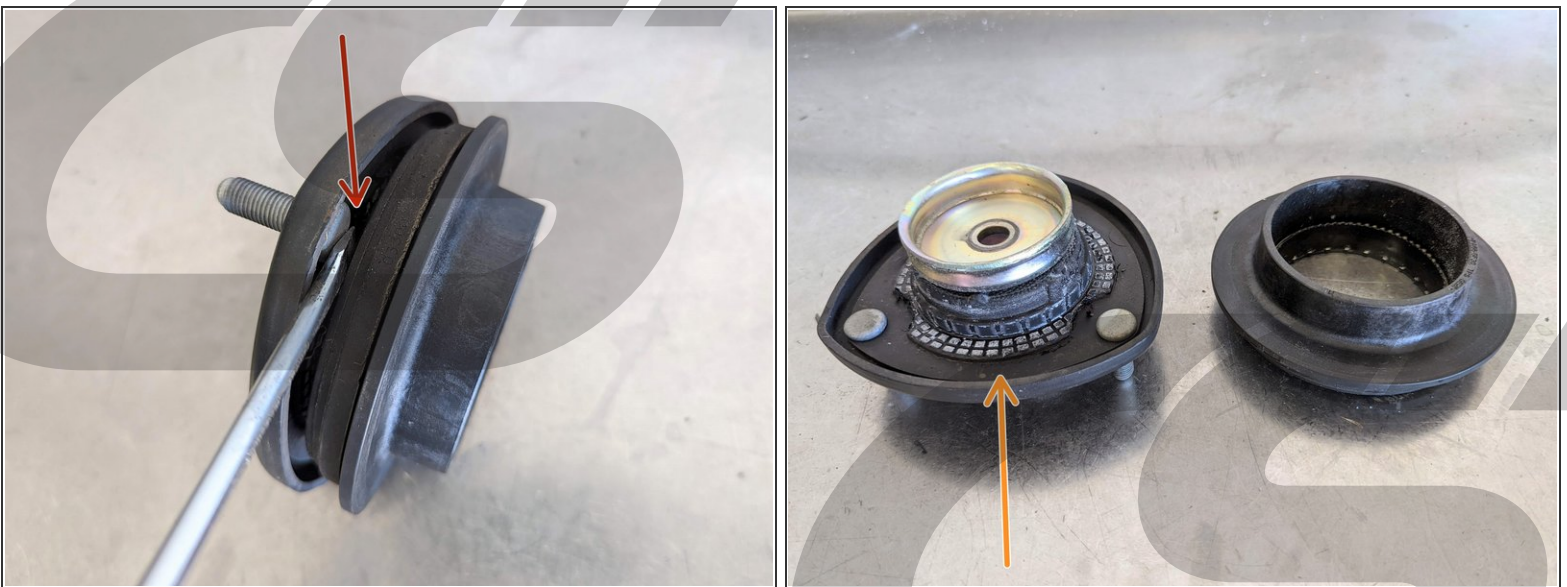

- Using a flat blade screwdriver, separate the strut top bearing from the rubber mount.
- Set the rubber mount aside as it will be replaced by the CS Camber Plate.

Step 14 — Setting the Camber Plate Adjustment Range

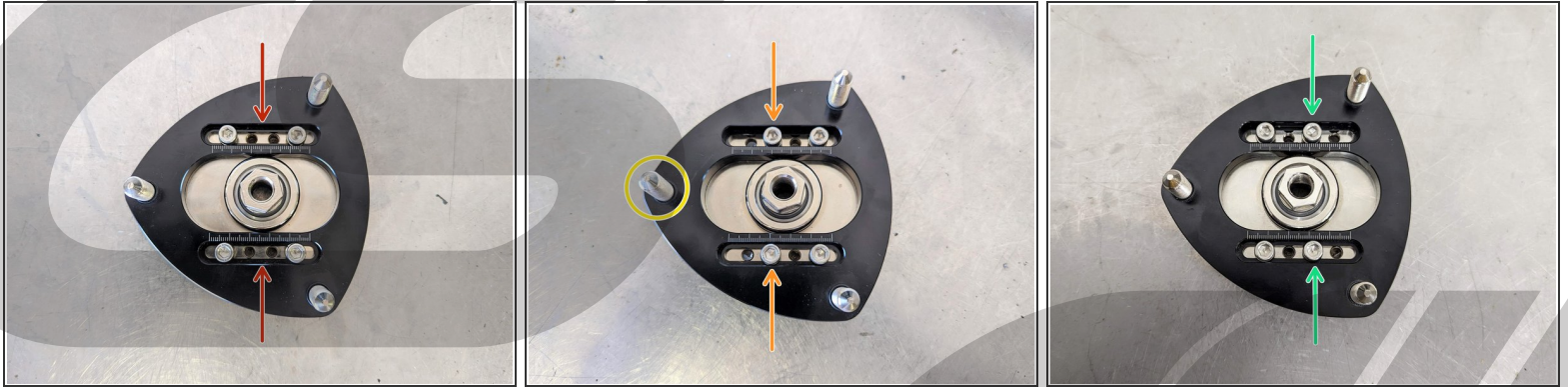

- The CS camber plates will come in the first configuration with the bolts spaced with two open holes between them.
- If you want to change your camber adjustment range to be able to achieve max negative camber, move the bolt to the right one hole to the position shown.
 - Make sure the camber plate is in the exact same orientation as shown with the one stud circled on the left side.
- If you want to change your camber adjustment range to be able to achieve max positive camber, move the bolt to the left one hole to the position shown.

Step 15 — Installing the CS Camber Plate - Part 1

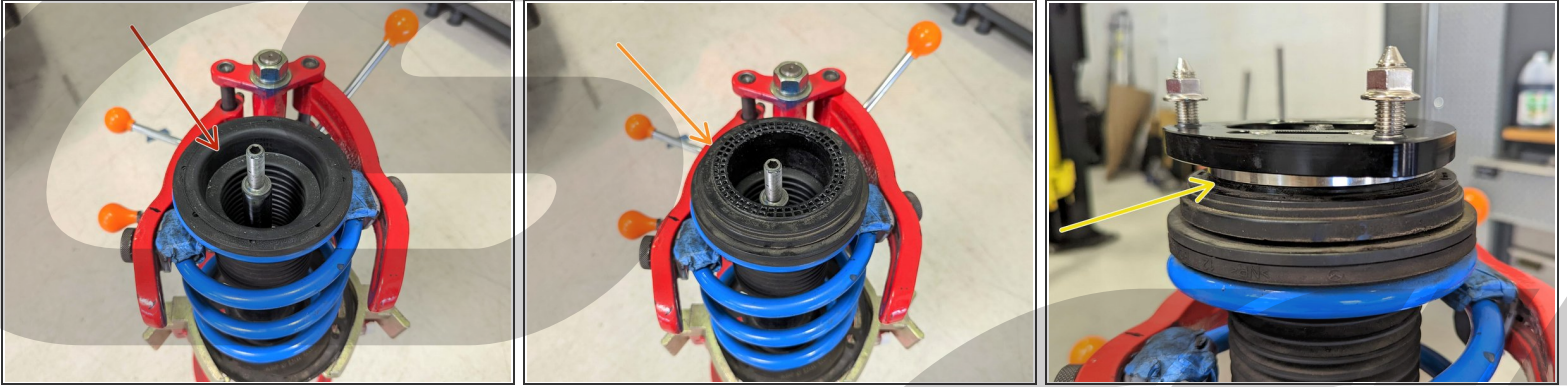

- If you are reinstalling the OEM springs place the bump stop, with the small end pointing downward, back on the strut.
- Place the rubber spring cushion and dust boot back on the spring.
- Reinstall the strut top bearing on the spring as shown.
- Place the CS camber plate on top of the strut bearing, making sure that it is properly centered and positioned as shown.

Step 16 — Installing the CS Camber Plate - Part 2

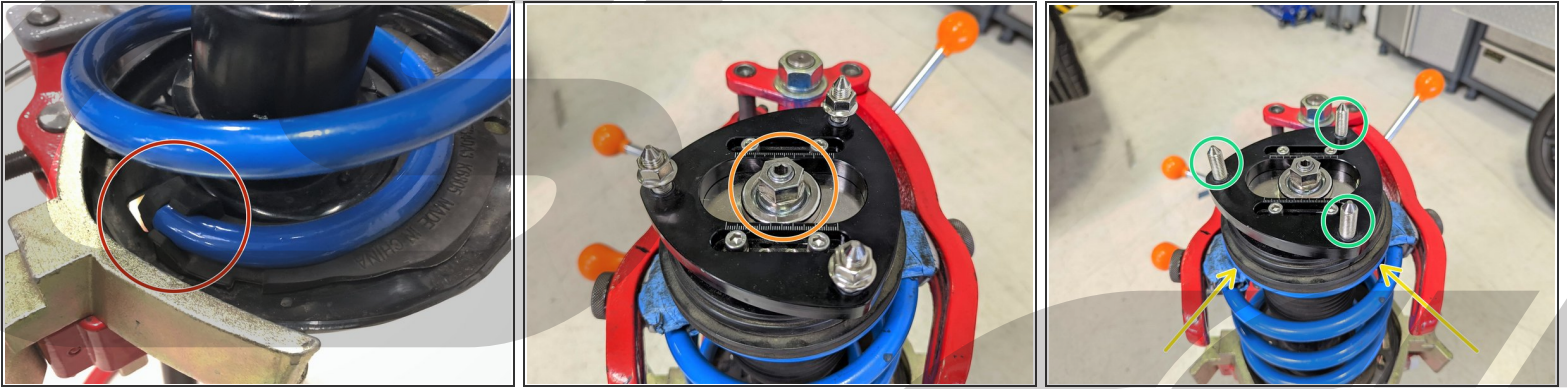

- Ensure that the bottom of the spring is fully seated in the spring seat as shown.
 - Start the provided 19mm nut by hand.
 - Tighten to **41-47ft-lbs.** using the method discussed in Step 11.
- ⓘ If tightening with an impact gun, ensure the pressure is turned down to about 60-80psi to prevent damage to the strut.
- Release the spring compressor slowly.
 - Check that the top coil of the spring is centered on the top hat and is touching all around.
 - Remove the 3 nuts on the studs if still installed on the camber plate.

Step 17 — Front Suspension Reassembly - Part 1

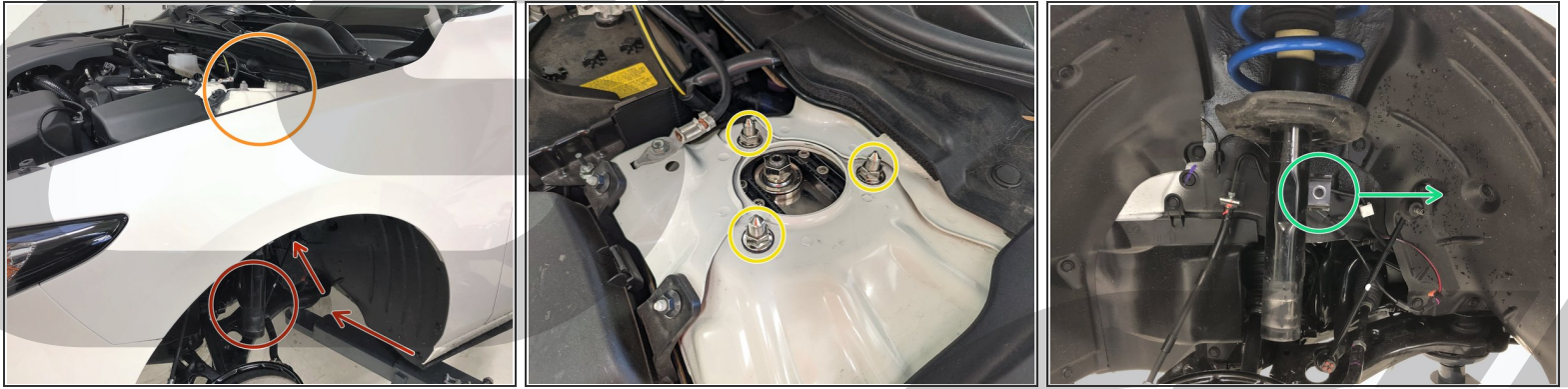

- Lift the assembled strut back into place.
- ⓘ Look in the fender to align the three top strut mounting studs to the three holes in the shock tower.
- Hold the bottom of the strut with one hand.
- ⓘ Ensure that the camber adjustment slots are pointing towards the other strut tower.
- Lightly push the strut through the three holes in the strut tower.
- Use the other hand to install the QTY(3) 15mm nuts.
- Tighten the three upper strut nuts to **37-43 ft-lbs.** using a 15mm socket.
- Rotate the strut as needed until the sway bar end link mount points toward the rear of the vehicle as shown.

Step 18 — Front Suspension Reassembly - Part 2

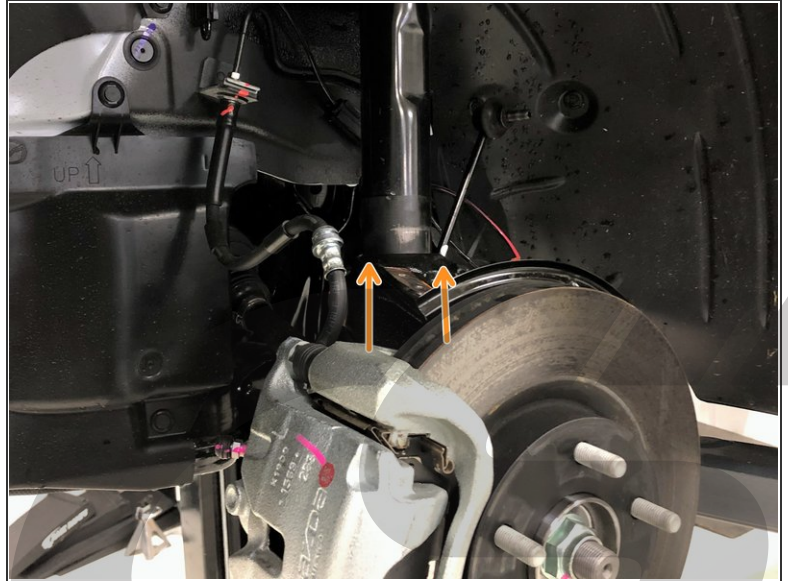
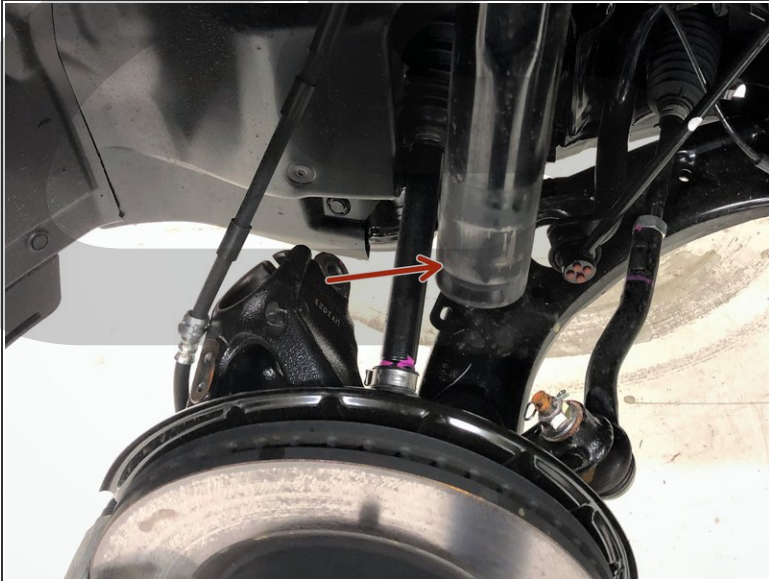

- Rotate the knuckle until the bottom of the strut aligns with the hole in the knuckle.
- Lift the knuckle upwards and start the bottom of the strut into the knuckle.

Step 19 — Front Suspension Reassembly - Part 3



- Using a hydraulic jack, lift the knuckle upwards from the lower control arm as shown.
- ⚠️ Ensure you are lifting from the area shown in the second image and not from the brake rotor or brake dust shield.

Step 20 — Front Suspension Reassembly - Part 4

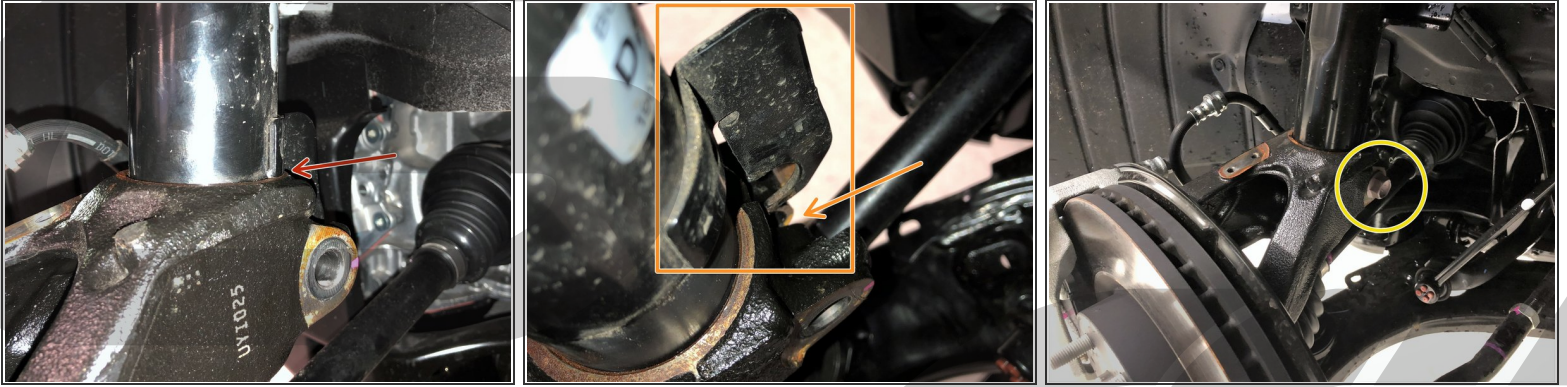

- Lift the suspension upwards until the knuckle hits the stop on the strut as shown.
- You may need to rotate the strut to fit the alignment tab in between the two sides of the knuckle.
- Once the hub stop is reached, install the 17mm strut pinch bolt and 19mm nut that were removed in Step 7.
- Tighten the strut pinch bolt to **48-54ft-lbs.**
- Lower the hydraulic jack once tightening is complete.

Step 21 — Front Suspension Reassembly - Part 5

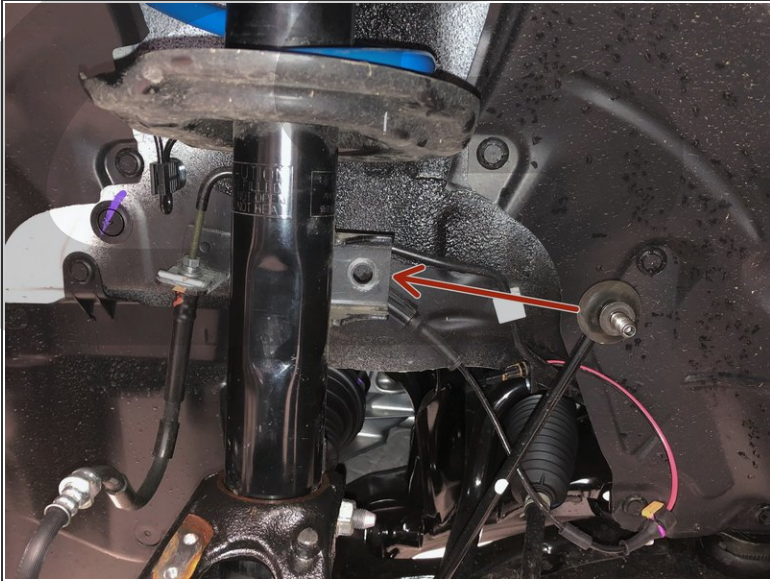

- Install the front sway bar end link through the mounting bracket on the strut.
- Secure the front sway bar end link by installing the nut removed in Step 6 and tightening to **34-40 ft-lbs** with a 14mm socket and ratchet.
- ⓘ If the nut is spinning without tightening, use a 5mm Allen key in the center to keep it secure and a 14mm wrench to tighten.

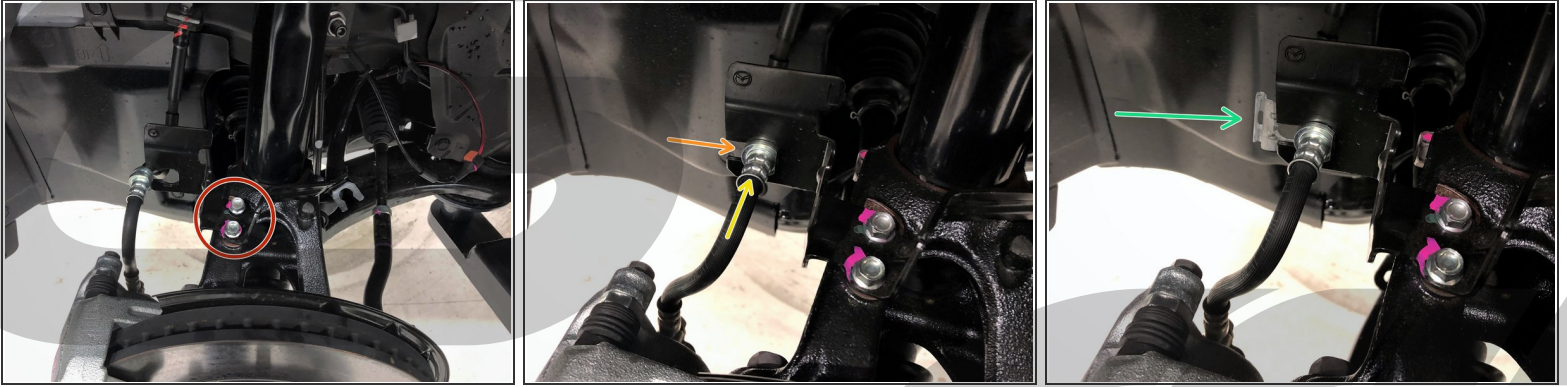
Step 22 — Front Suspension Reassembly - Part 6

- Install the brake line and ABS wiring mounting bracket onto the knuckle. Tighten the two 10mm bolts until snug using a 10mm socket and ratchet.
 - Insert the brake line into the mounting bracket you removed it from earlier.
 - Push forward on the line slightly to ensure it is fully seated, then secure the brake line with the retaining clip.
 - Ensure the retaining clip is in the orientation shown.
- ⓘ You may need to tap the retainer clip gently with a hammer in order to get it fully installed.

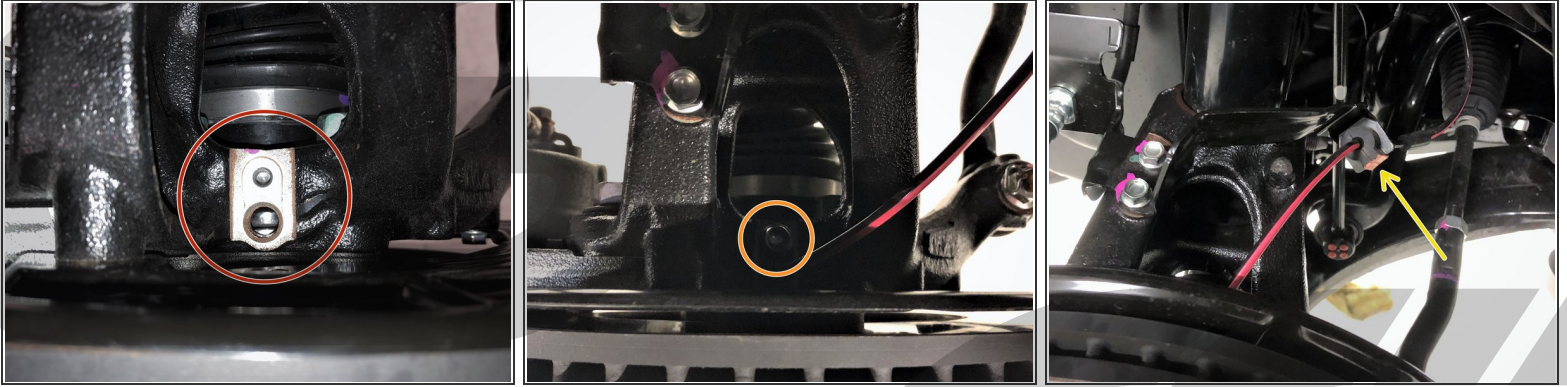
Step 23 — Front Suspension Reassembly - Part 7

- Reinstall the ABS sensor into the knuckle near the brake rotor. Press it down gently to ensure it is fully seated.
- Secure the ABS sensor with the 10mm bolt removed earlier. Tighten until snug with a 10mm socket and ratchet.
- Secure the ABS wiring in the mounting bracket. Push the rubber portion of the wiring onto the bracket until it is snug.

Step 24 — Camber Settings

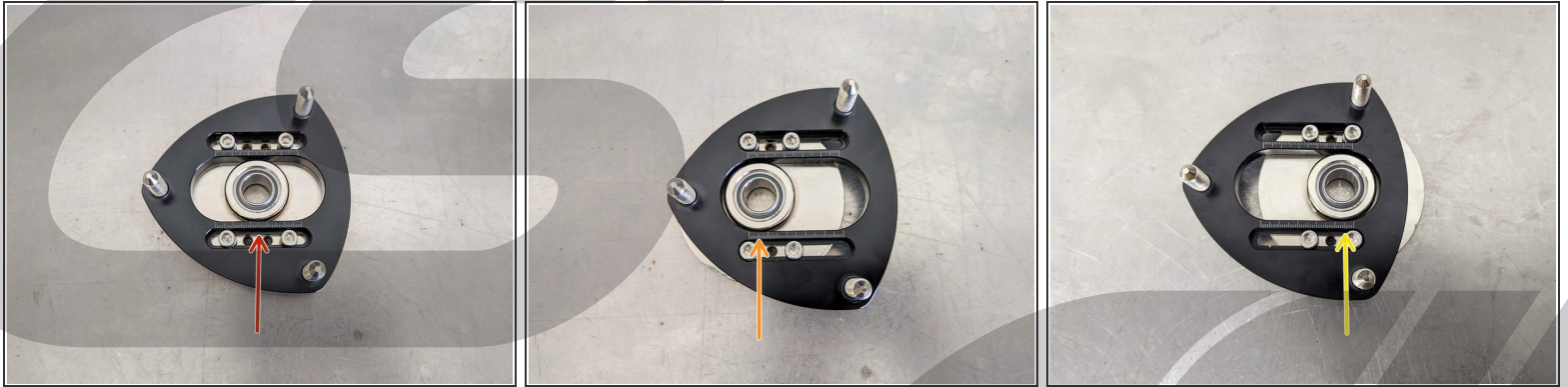

- Set an initial camber setting.
 - The center of the adjustment range is roughly the stock camber setting.
 - All the way towards the center of the vehicle is roughly -2.4 degrees if there is one hole between the bolts as shown.
 - ⓘ If you want to run the max negative camber setting, a ball end 5mm Allen socket will need to be used to get the additional angle that is required to access the inside bolts.
 - All the way towards the outside of the vehicle is roughly +0.9 degrees if there is one hole between the bolts as shown.
 - Once the camber is set to approximately where you would like, tighten the 5mm Allen bolts on the camber plate to 6 ft-lbs.
- ⚠ It is recommended that you have your car aligned after the installation to ensure camber, toe and caster values are correct.**

Step 25 — Front Suspension Wrap Up



- Repeat steps 2-24 for the right side of the vehicle.
- Reinstall both front wheels. Using a 17mm or 21mm socket on each of the 5 lug nuts.
- Lower the front of the car down off the jack stands.
- Torque the lug nuts in a star pattern to **80-90ft-lbs.**

Step 26 — Installation Complete



- This completes your installation of the CorkSport Performance Camber Plates!
- ⓘ Listen for any strange noises upon first drive. If any are present, inspect the suspension.
- Contact us with any questions or concerns at sales@corksport.com or (360) 260-2675.
- Please leave a review here: <https://corksport.com/>
- Share your experience using #CorkSport on Instagram, Facebook, and Twitter.