

INSTALLATION INSTRUCTIONS



CORKSPORT CST4

2007-2013 Mazdaspeed 3, 2006-2007
Mazdaspeed 6, 2007-2012 Mazda CX-7 Turbo

PART #: GEN-6-777

Need Help With Your Installation? Call (360) 260-CORK



We absolutely, positively,
deliver - every time.

CORKSPORT.COM

CORKSPORT CST4

2007-2013 Mazdaspeed 3, 2006-2007
Mazdaspeed 6, 2007-2012 Mazda CX-7 Turbo

Recommended:

- Oil Drain Pipe Gasket, Upper Mazda P#: L3K914293
- Oil Drain Pipe Gasket, Lower Mazda P#: L3K914264
- CorkSport EWG Dumptube P#: GEN-6-575-19

PRODUCT DESCRIPTION:

Thank you for purchasing a CorkSport Upgraded Turbocharger for your Mazdaspeed. Achieve your power goals whether your on stock block with a CST4 or going for big power on a built engine with a CST6. Both internal wastegate and external wastegate options offer great boost control so you can build you car exactly how you want it. Each turbo uses the OEM mounting location with all the lines and hardware needed for a quick and easy install.

Please let us know your feedback of the by submitting a review at: <https://corksport.com/mazdaspeed-3-and-6-turbo-upgrade.html>

PRE-INSTALLATION NOTES:

 Verify that the car is on a level surface before proceeding. Use appropriate load rated jack stands to support the vehicle.

 These instructions were written for reference only and the use of a factory service manual is recommended.

 A re-tune will be required to safely operate any of the CorkSport Turbochargers. The wastegate duty cycles and ignition timing maps will need to be modified. We recommend contacting a professional tuner.

 Make sure your vehicle is cooled down prior to starting installation. If you are going to work on your car within an hour of having driven it, use a fan to cool off the car.

 These instructions were written using a 2009 Mazdaspeed 3. GEN2 MS3 and Mazdaspeed 6 will be similar.

MATERIALS & TIME:

GENERAL INFO:



Time Est:
5hr



Difficulty:
4/5



CEL:
No



Warranty:
2-Year









PARTS LIST (CST4):

- One (1) Assembled CST4 CorkSport Turbocharger in IWG or EWG configuration
- One (1) Turbine to Downpipe Gasket
- One (1) Turbine to Exhaust Manifold Gasket
- One (1) M12x1.25x25 Oil Feed Banjo Bolt
- Two (2) M12 Copper Crush Washers
- Nine (9) Turbine Studs
- Three (3) M6x1.0x12mm Bolt
- Nine (9) Crimp Nuts
- One (1) Coolant Line
- Four (4) M14 Copper Crush Washers
- One (1) M8x1.25x12mm Bolt
- IWG ONLY:**
- One (1) Turbine Heat Shield
- Three (3) M6x1.0x10mm Cap Screws
- EWG ONLY:**
- One (1) CorkSport EWG Elbow
- One (1) CorkSport EWG v-band Clamp

TOOLING LIST:

- Flat Head Screwdriver
- Phillips Screwdriver
- Channel Lock Pliers
- Needle Nose Pliers
- Small Vice Grips (x2)
- 8mm Socket & Wrench
- 10mm Socket & Wrench
- 12mm Socket & Wrench
- 14mm Socket & Wrench
- 17mm Socket (1/2" Drive)
- 19mm Socket (1/2" Drive)
- 21mm Socket (1/2" Drive)
- Ratchet Wrench (3/8" & 1/2")
- 4" Extension (3/8" & 1/2")
- 12" Extension (3/8" & 1/2")
- Oxygen Sensor Socket
- 1/2" Semi-Wobbler Joint
- WD 40 or similar
- Torque Wrench
- Coolant Drain pan
- Engine Coolant
- High Temperature Anti-Seize

ORDER OF OPERATIONS & TABLE OF CONTENTS:

	VEHICLE DISASSEMBLY	
	Section 1: Removing the OEM Intake	Pg. 4-5
	Section 2: Removing the Battery Box & ECU	Pg. 5-7
	Section 3: Removing the OEM Turbo Inlet Pipe	Pg.7-8
	Section 4: Removing the OEM TMIC	Pg. 8-9
	Section 5: Removing the OEM Heatshields	Pg. 10
	MAZDASPEED 3 ONLY SECTION	
	MS3 Section 6: Disassembling the Downpipe	Pg. 11-12
	MS3 Section 7: Removing the Lower Turbocharger Components	Pg. 13
	MAZDASPEED 6 ONLY SECTION	
	MS6 Section 6: Disassembling the Downpipe	Pg. 14-15
	MS6 Section 7: Removing the Lower Turbocharger Components	Pg. 16
	VEHICLE DISASSEMBLY CONTINUED	
	Section 8: Clearing a Path for the Turbocharger	Pg. 17-19
	Section 9: Removing the OEM Turbocharger	Pg. 19-20
	TURBOCHARGER SETUP & INSTALLATION	
	Section 10: CST4 IWG Setup & Installation	Pg. 21-23
	Section 11: CST4 EWG Setup & Installation	Pg. 24-26
	INTERNAL WASTEGATE SETUP	
	Section 12: CST4 IWG Setup	Pg. 27-29
	EXTERNAL WASTEGATE SETUP	
	Section 13: CST4 EWG Setup	Pg. 30-32
	VEHICLE REASSEMBLY	
	Section 14: Reassembling the Vehicle & First Startup	Pg. 33

DETAILED INSTRUCTIONS:

1. Removing the OEM Intake



We strongly recommend a sharpie and plastic bags to label all hardware throughout install.

- a) Remove the top mount intercooler (TMIC) cover by removing the two 10mm bolts (red circles in Figure 1a).

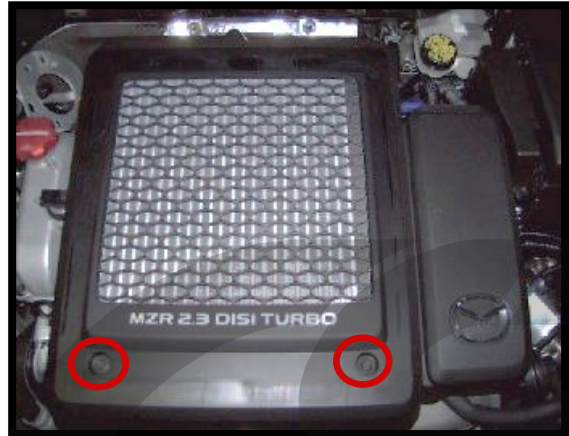

Figure 1a

- b) Loosen the two (2) 10mm hose clamps on the factory rubber intake elbow (red circles in Figure 1b).

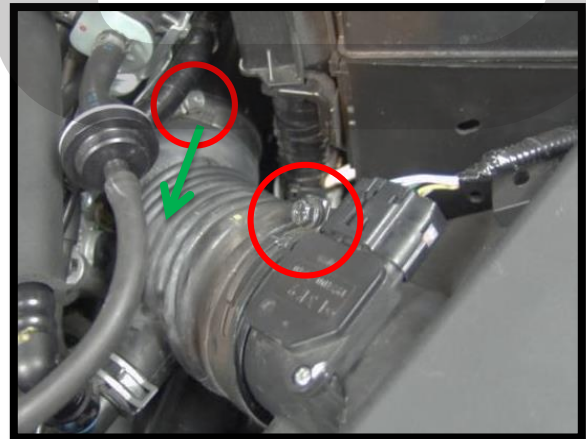

Figure 1b

- c) Pull the OEM intake elbow off the OEM turbo inlet pipe. Pull in direction shown with green arrow in Figure 1b.

- d) Unplug the MAF sensor located on the air filter housing (green circle in Figure 1c).

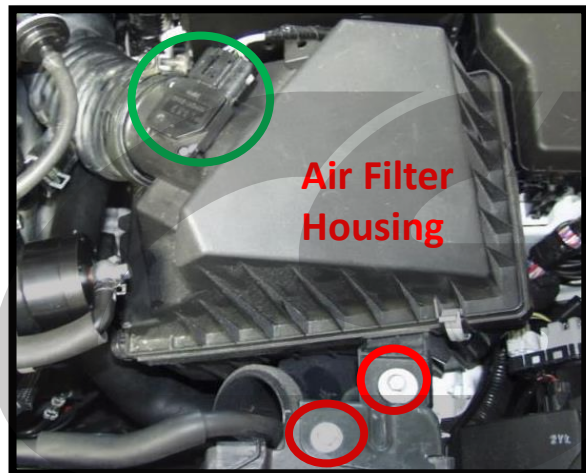

Figure 1c

- e) Remove the two 10mm bolts on the air filter housing bracket and remove the bracket (red circles in Figure 1c).



Mazdaspeed 6 does not have the bolts referenced in step 1e. Skip this step if you have an MS6.

DETAILED INSTRUCTIONS:

1. Removing the OEM Intake (continued)

- f) Remove the valve cover breather tube. Push the hose connector toward the valve cover and press both sides of the colored clip simultaneously. Pull the hose away from the valve cover (**Figure 1d**).

- g) Pull up on the filter housing to pop it free from the car and remove it along with the intake elbow and breather tube.

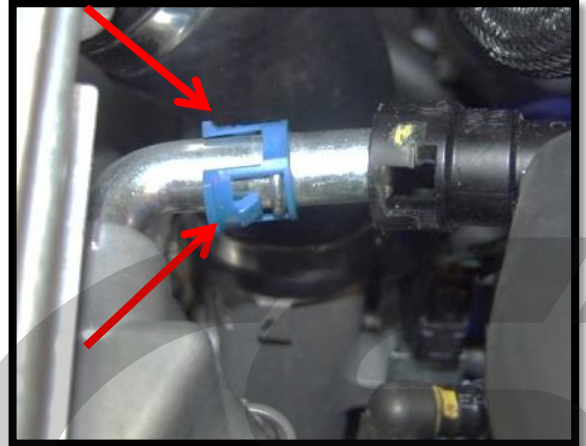

Figure 1d

2. Removing the Battery Box & ECU

NOTE Mazdaspeed 6 has a battery tray instead of a battery box. Also, the ECU does not need to be removed. Only follow steps 2b, 2c, and 2g for battery tray removal if installing on MS6.

- a) Remove the battery box cover. The cover is held on with two clips (shown with **red arrows** in **Figure 2a**). Pry the clips outward by hand and lift the front of the lid off of the box. The **green arrow** in **Figure 2a** shows the location of the ECU.

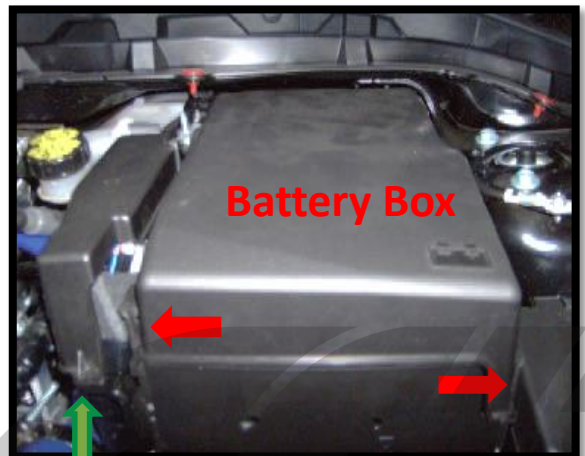

Figure 2a

DETAILED INSTRUCTIONS:

2. Removing the Battery Box & ECU (cont.)

- b) Disconnect the battery. Disconnect the battery terminals with a 10mm end wrench. Refer to **Figure 2b** for negative (-) and positive terminals (+). Disconnect the negative terminal of the battery first, then the positive terminal (**Figure 2b**).

- c) Remove the two 10mm nuts for the battery tie down bracket (shown with **red circles** in **Figure 2b**).

- d) Remove the battery from the battery box.

- e) Remove the front battery box panel. Remove the MAF wiring harness clip (**blue circle Figure 2c**), and negative battery cable clip (**purple circle Figure 2c**), from the front battery box panel using needle nose pliers to compress the clips on the inside of the battery box. Then slide the panel upwards and remove it (**green arrow** in **Figure 2c**).

- f) Disconnect the ECU plugs by pushing on the tabs (**red arrows** in **Figure 2d**) and pulling the white lock upward simultaneously (**green arrows** in **Figure 2d**). Refer to **Figure 2b** for location of ECU plugs and **Figure 2d** for close ups.



Do not force the ECU plugs. When done correctly, they will come apart very easily.

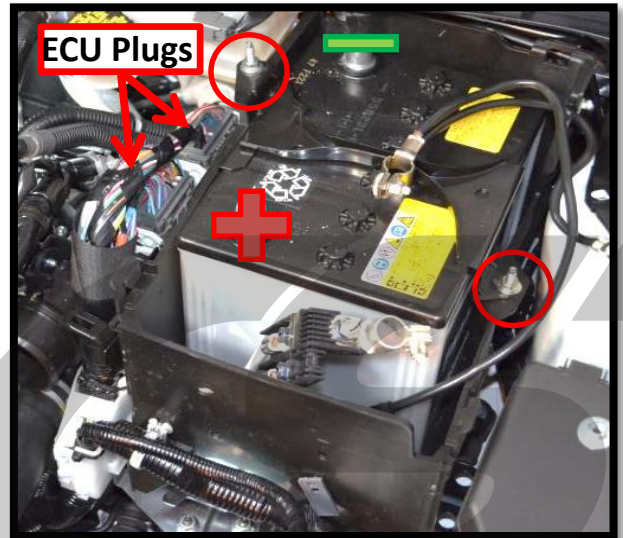

Figure 2b

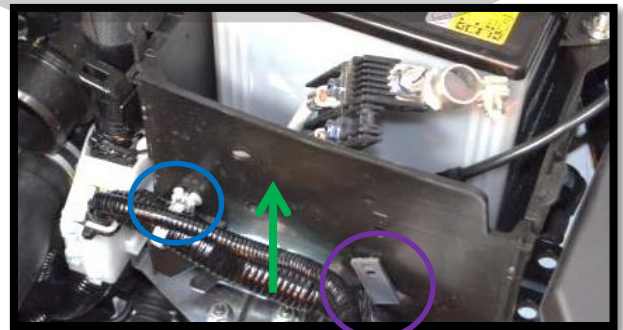

Figure 2c

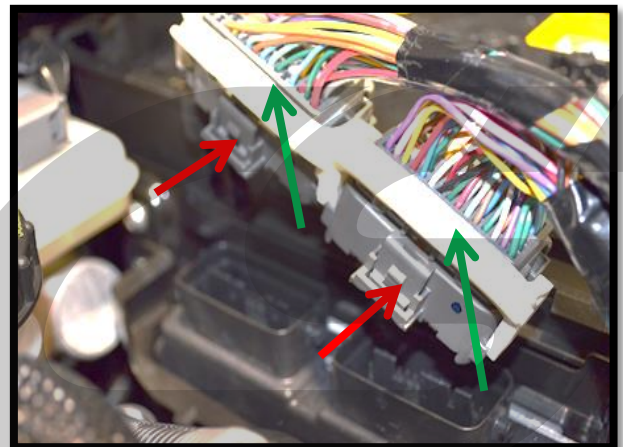

Figure 2d

DETAILED INSTRUCTIONS:

2. Removing the Battery Box & ECU (cont.)

- g) Remove the battery box. Remove the three 10mm bolts in the bottom of the box, and remove the battery box and ECU (red circles Figure 2e).

NOTE

Mazdaspeed 6 vehicles have two (2) 10mm bolts holding the battery tray instead of three (3). In addition, you must release the wiring harness clip at the front of the battery tray for removal.

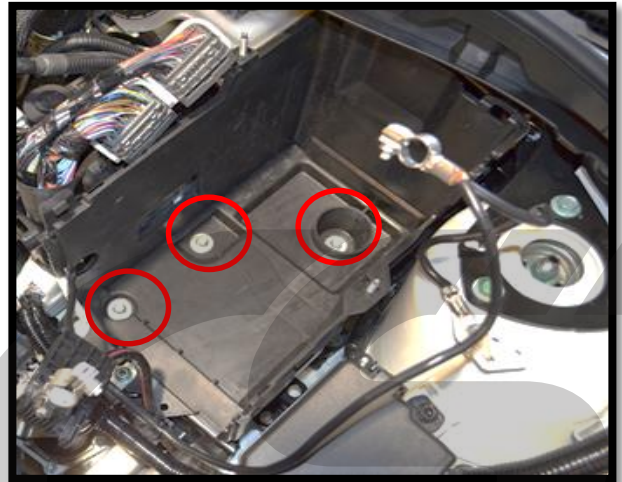

Figure 2e

3. Removing the OEM Turbo Inlet Pipe (TIP)

- a) Release the hose clamps on the bypass valve hose (red circles in Figure 3a) using channel lock pliers. Remove the BPV hose from the car and save if you are re-using it. You can discard the rubber hose and spring clamps if you will be installing the CorkSport Silicone BPV Hose.

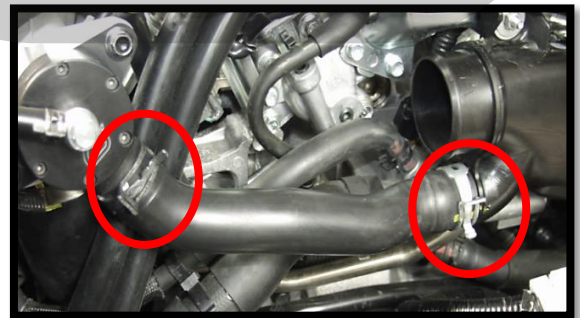

Figure 3a

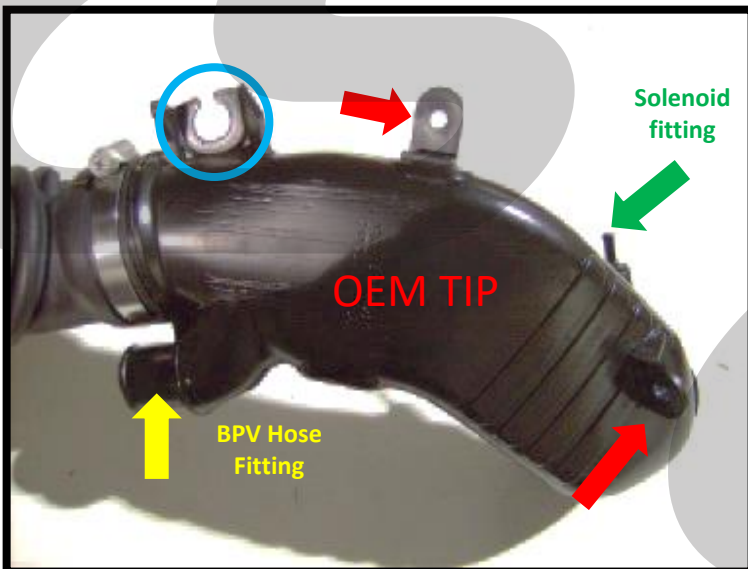

Figure 3b

- b) Remove the 10mm nut that holds the stock turbo inlet pipe in place (blue circle in Figure 3b).
- c) Remove the two wiring harness clips (red arrows in Figure 3b) located on the stock turbo inlet pipe.

DETAILED INSTRUCTIONS:

3. Removing the OEM TIP (cont.)



Use extreme caution when performing the next step. The plastic barb can break off very easily.

- d) Using needle nose pliers, release the small spring clamp from solenoid fitting on the OEM TIP (see the **green arrow** in **Figure 3b** on the previous page). Then remove the small hose from this same fitting.



If you are having difficulty this hose loose, try rotating the hose to break the seal of the rubber to the plastic fitting and then pulling straight up. It takes a little force but cleanly comes off.

- e) Remove the plastic inlet pipe from the turbocharger. Loosen the 10mm hose clamp at the turbo inlet, pull the OEM TIP off of the turbocharger, and remove it from the car.

4. Removing the OEM Top Mount Intercooler (TMIC)

- a) Remove the clamps for the throttle body and turbo boost tubes from the intercooler. Use a 10mm socket to loosen the clamps (**red circles** in **Figure 4a**).

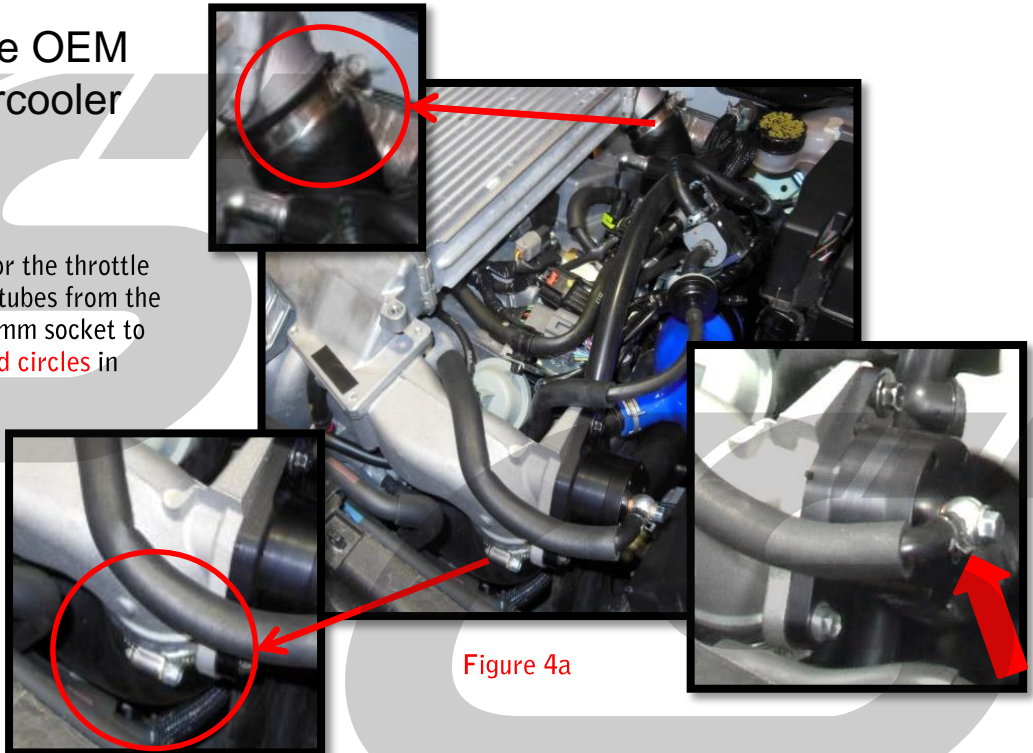

Figure 4a

DETAILED INSTRUCTIONS:

4. Removing the OEM TMIC (cont.)

- b) Detach the bypass valve (BPV) signal hose from the BPV. Release the spring clamp and then remove the signal hose from the BPV (red arrow in **Figure 4a** on previous page). Leave the bypass valve attached to the intercooler pipe.
- c) Remove the three (3) 12mm nuts fastening the intercooler to the top of the engine (red circles in **Figure 4b**).
- d) Remove the OEM intercooler from the vehicle by pulling upwards to release it from the boost tubes & mounting studs.
- e) Remove the outlet boost tube from the turbocharger. Use a 10mm socket and ratchet or #2 Phillips screwdriver. See red circle in **Figure 4c**.

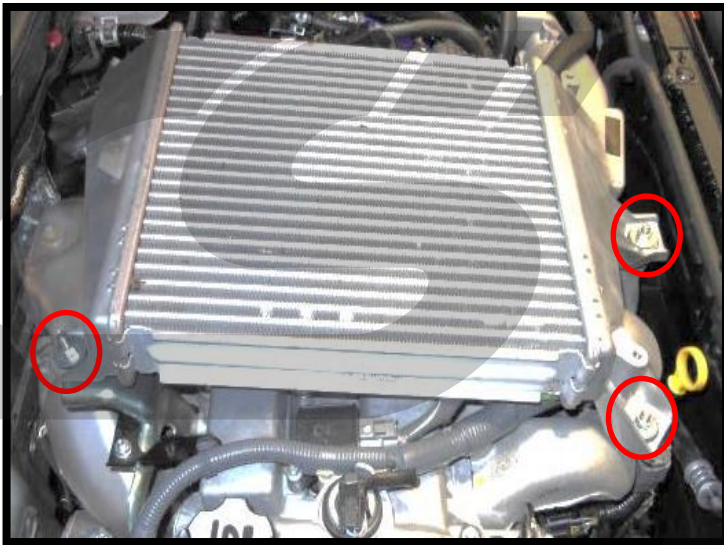

Figure 4b



Figure 4c

DETAILED INSTRUCTIONS:

5. Removing the OEM Heatshields

- a) Remove thin silver firewall heat shield shown with the **green arrow** in **Figure 5a**. There are three plastic clips that unscrew.



Mazdaspeed 6 vehicles do not have this heatshield.

- b) Remove the six 8mm bolts **circled in red** in **Figure 5a**, then remove the heat shield.



Step 4b is optional for turbo install/removal. However, we strongly recommend doing so for ease of access to downpipe bolts.

- c) Remove the three 8mm bolts holding the lower heat shield shown with the **red arrow** in **Figure 5b** and the **red circles** in **Figure 5c**. Then remove the heatshield.

- d) Remove the three 8mm bolt **circled in green** in **Figure 5b**. Then remove the heatshield.

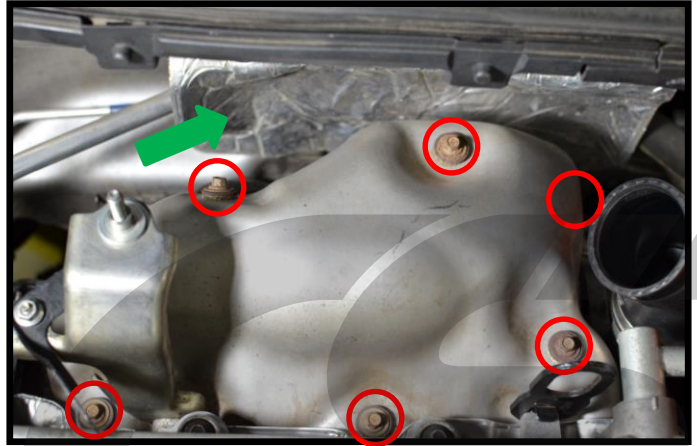

Figure 5a

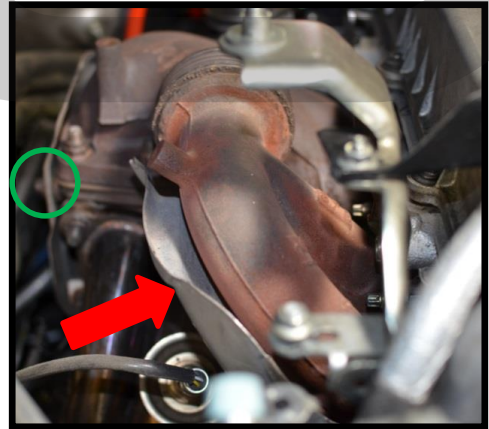

Figure 5b

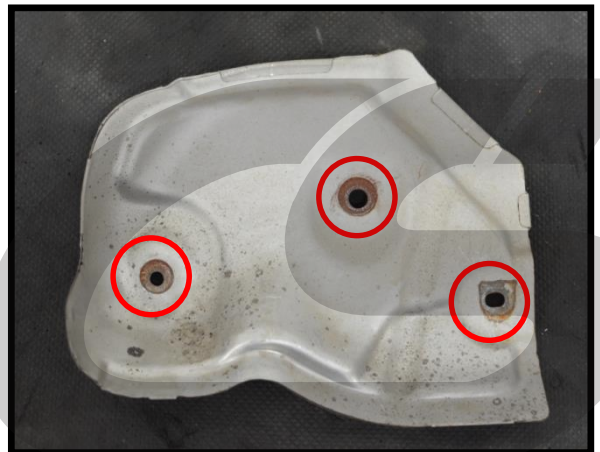

Figure 5c

DETAILED INSTRUCTIONS:



The downpipe disassembly has been broken up into Mazdaspeed 3 and Mazdaspeed 6 sections for clarity.

Mazdaspeed 3 owners continue on this page.

Mazdaspeed 6 owners continue on page 14.

6. Disassembling the Downpipe (Mazdaspeed 3)



Vehicle shown had a CorkSport downpipe installed. Disassembly of OEM or other downpipe will be similar.

- a) Remove the upper oxygen sensor using an oxygen sensor socket and $\frac{1}{2}$ " drive ratchet. **Circled in red in Figure 6a.**
- b) Remove the three 14mm nuts **circled in red** and shown with the **red arrow** in **Figure 6b.**



Figure 6a



Oxygen Sensor
Socket

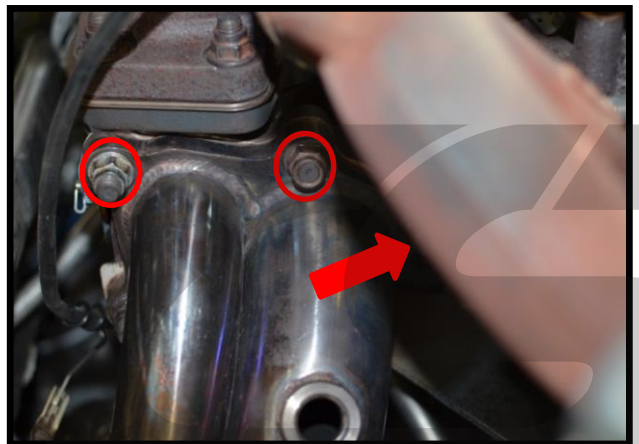

Figure 6b

DETAILED INSTRUCTIONS:

6. Disassembling the Downpipe (Mazdaspeed 3) (cont.)

- c) Remove the second oxygen sensor with an oxygen sensor socket and $\frac{1}{2}$ " ratchet, circled in red in Figure 6c.
- d) Remove the two 17mm (14mm for OEM) bolts between the downpipe and the catback exhaust (CBE), circled in red in Figure 6d. (If applicable) Remove the 17mm (14mm for OEM) bolts between the race pipe and upper downpipe.
- e) Remove the exhaust hangers from the downpipe, shown with the red arrows in Figure 6c.

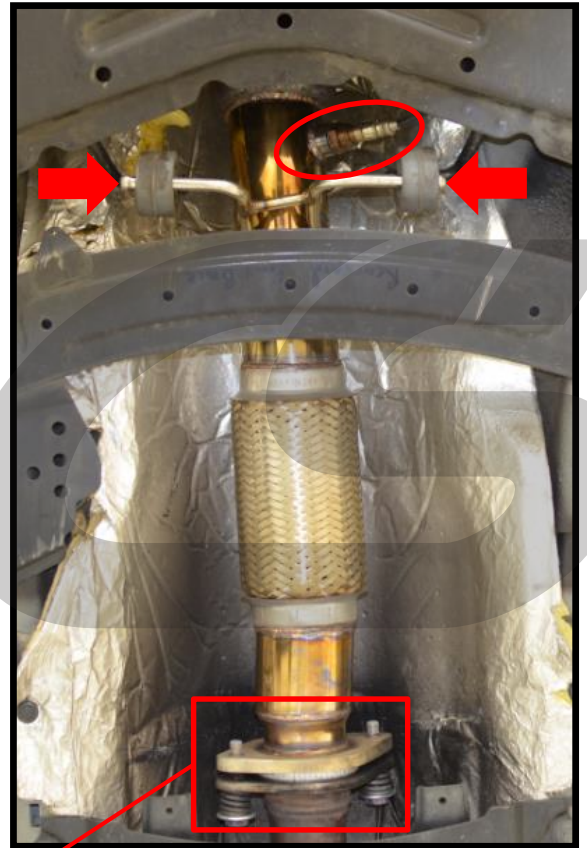

Figure 6c

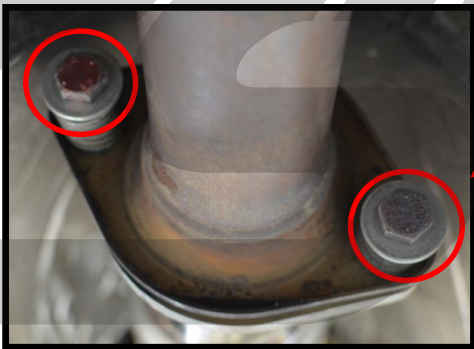

Figure 6d

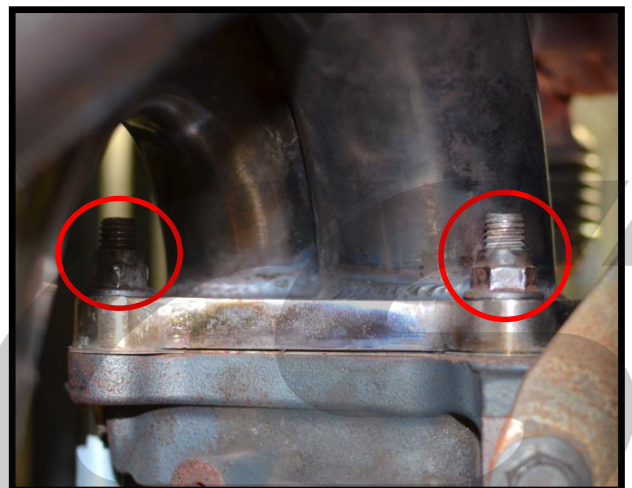

Figure 6e

- f) Remove the lower remaining two 14mm nuts from the downpipe, circled in red in Figure 6e.
- g) Leave the downpipe loose in the engine bay for turbo removal/install.

DETAILED INSTRUCTIONS:

7. Removing the Lower Turbo Components (Mazdaspeed 3)

- Drain approximately 1 gallon from the coolant system. Use a large flathead screwdriver to loosen the drain valve located on the lower driver's side of the radiator. Red circle in **Figure 7a**.
- Remove the lower coolant line from the turbo, shown with the red circle in **Figure 7b**.
- Remove the four 8mm bolts holding the oil drain line, shown from under the car with the green arrow & circles in **Figure 7b**.



Be careful to not loose or damage the oil drain gaskets if you plan to reuse them. They can be reused if in good condition.



The bolts that connect the oil drain to the block are longer than the bolts that go into the turbo. Note this for reinstall.

- Remove the three 14mm bolts holding the turbo support bracket, circled in blue in **Figure 7b**.

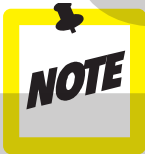

Mazdaspeed 3 owners continue on page 17.



Figure 7a

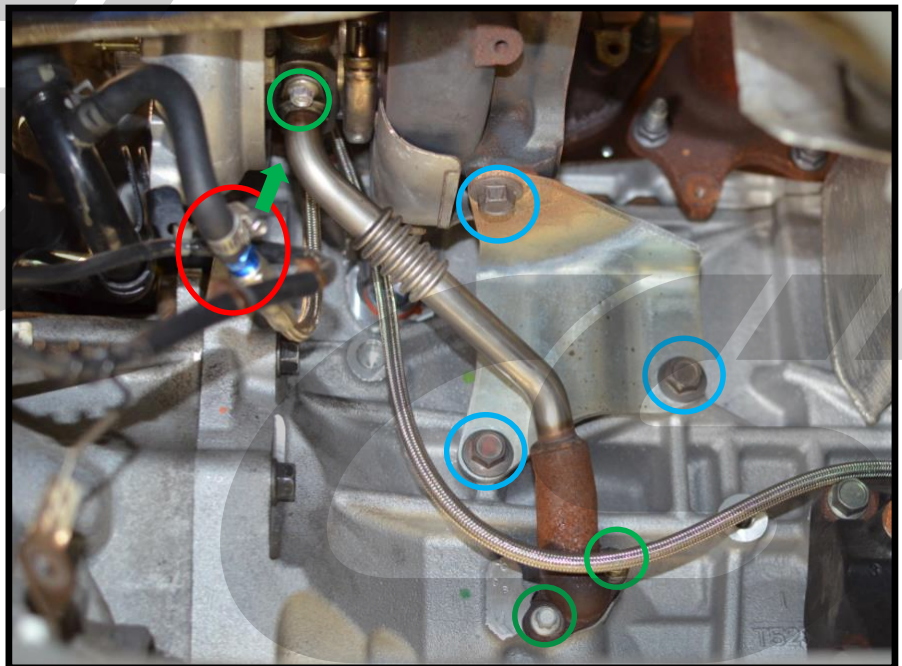

Figure 7b

DETAILED INSTRUCTIONS:

6. Disassembling the Downpipe (Mazdaspeed 6)

a) Remove the upper oxygen sensor using an oxygen sensor socket and $\frac{1}{2}$ " drive ratchet. **Circled in green in Figure 6a.**

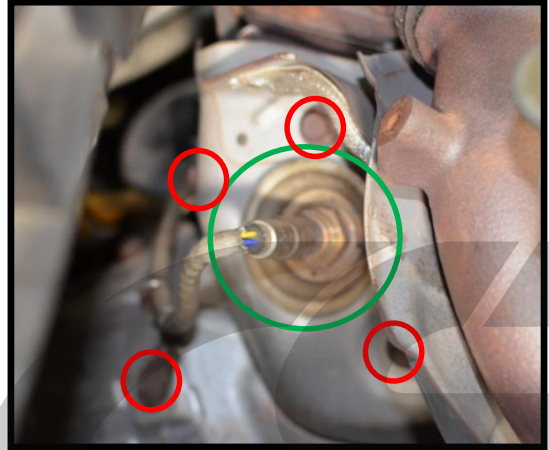

Figure 6a

b) Remove the four 10mm bolts **circled in red in Figure 6a.** Then, remove the heat shield covering the downpipe nuts.

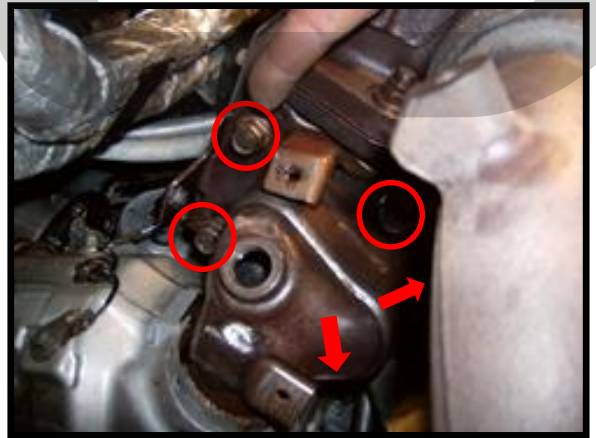

Figure 6b

c) Remove the five 14mm nuts attaching the downpipe to the turbo. Shown with **red circles and arrows in Figure 6b.**

d) Remove the six 10mm bolts holding the engine undertray. **Red circles in Figure 6c.** Remove the engine undertray.

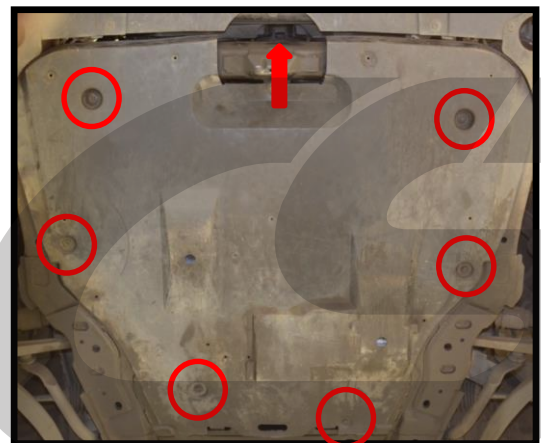

Figure 6c

e) Drain approximately 1 gallon from the coolant system. The drain is centered on the bottom of the radiator. See the **red arrow in Figure 6c.**

DETAILED INSTRUCTIONS:

6. Disassembling the Downpipe (Mazdaspeed 6) (cont.)

- f) Remove the lower oxygen sensor. **Green circle** in **Figure 6d**.
- g) Remove the two 14mm bolts attaching the racebook to the cat back exhaust. **Red circles** in **Figure 6d**.
- h) Remove the two 14mm nuts attaching the racebook to the downpipe. **Red circles** in **Figure 6e**.
- i) Remove the four 14mm bolts holding the downpipe support bracket. **Red circles** in **Figures 6f & 6g**.
- j) Leave the downpipe loose in the engine bay for turbo removal.

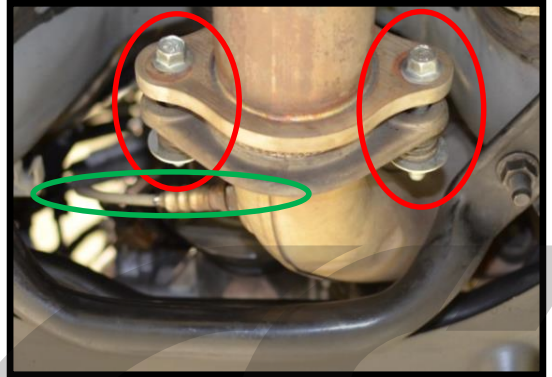

Figure 6d

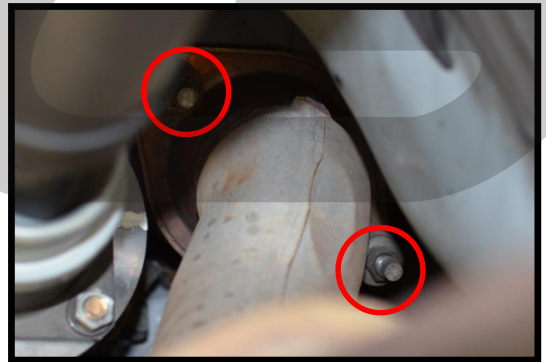

Figure 6e



Figure 6g



Figure 6f

DETAILED INSTRUCTIONS:

7. Removing the Lower Turbo Components (Mazdaspeed 6)



Since the MS6 transfer case makes these components hard to see, Figure 7a below is from a Mazdaspeed 3. Most of the disassembly on this page will need to be done from above the engine by feel. All locations are identical to MS3.

- Remove the lower coolant line from the turbo, shown with the red circle in Figure 7a.
- Remove the two 8mm bolts holding the oil drain line to the turbocharger, shown with the green arrow & circle in Figure 7a.



The transfer case makes removal of the lower oil drain bolts very difficult so we recommend leaving the oil drain attached to the engine block. You must take care to not bend or damage the oil drain during turbocharger removal/install.

- Remove the three 14mm bolts holding the turbo support bracket, circled in blue in Figure 7a.



Be careful to not lose or damage the oil drain gaskets if you plan to reuse them. They can be reused if in good condition.

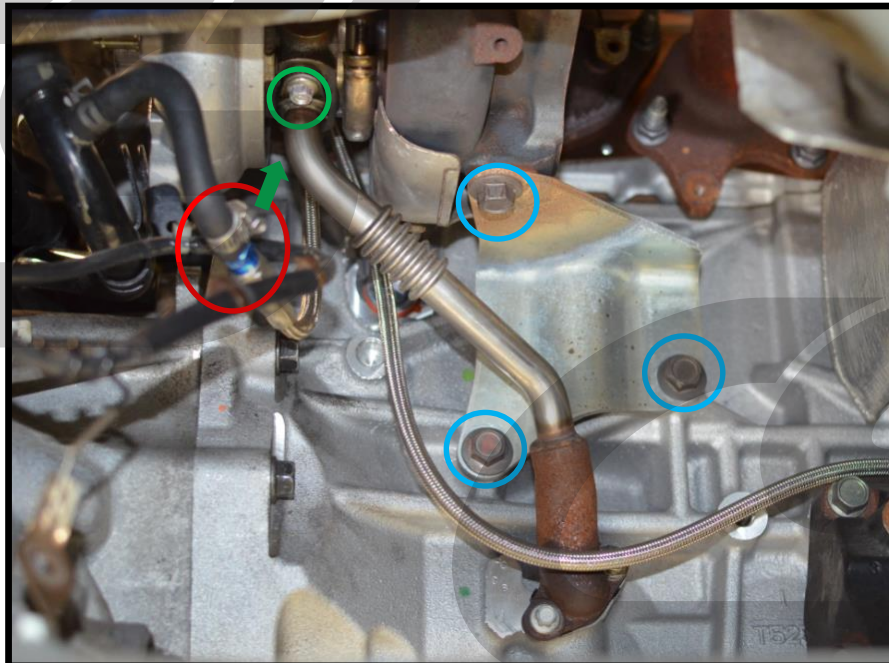

Figure 7a

DETAILED INSTRUCTIONS:

8. Clearing a Path for the Turbocharger

- a) Remove the three 10mm flange nuts holding the brake booster heat shield. **Red circles** in **Figure 8a**.
- b) Disconnect the electrical connector from the OEM electronic boost control solenoid (EBCS).



The ports on the OEM EBCS are fragile and can break off easily.



The OEM EBCS is located on the compressor housing near the outlet.



If installing an aftermarket EBCS with your CS turbocharger, the OEM EBCS can be removed with the OEM turbo.

- c) Remove the OEM EBCS. Using a 10mm wrench, remove the flange nut. Shown with the **red circle** in **Figure 8b**.

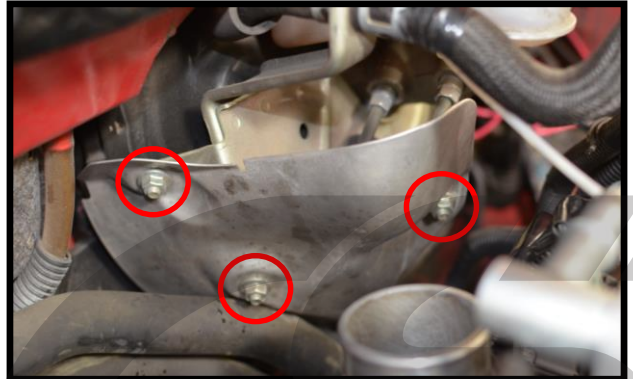
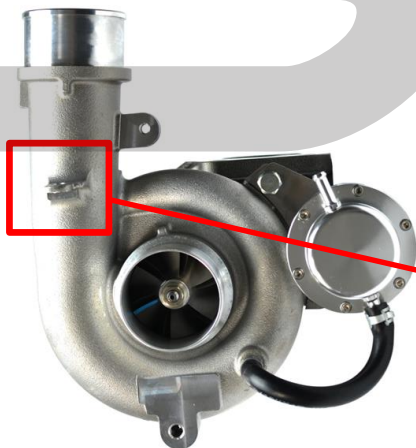

Figure 8a

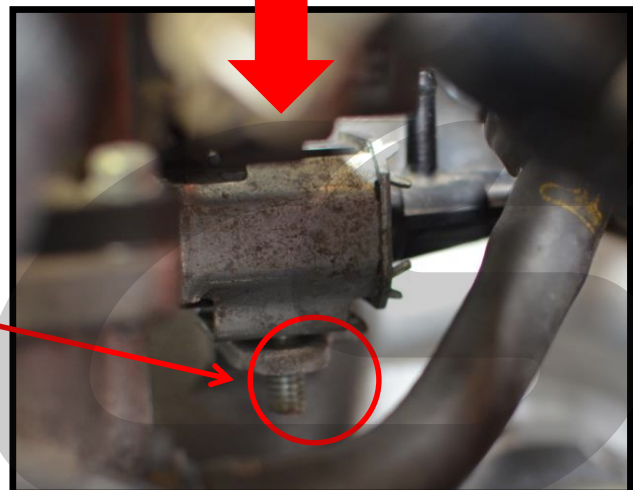

Figure 8b

DETAILED INSTRUCTIONS:

8. Clearing a Path for the Turbocharger (cont.)

- d) Disconnect the four electrical connectors circled in red in **Figure 8c**.
- e) Release the spring clamp on the upper coolant line that routes from the EGR valve to the turbocharger. Then, pull the line off the turbocharger. Coolant line showed with the **blue arrow** in **Figure 8d**.
- f) Remove the two 10mm flange bolts holding the EGR valve. The mounted EGR valve is shown in **Figure 8d** and the bolt locations are shown in **Figure 8e** circled in red.

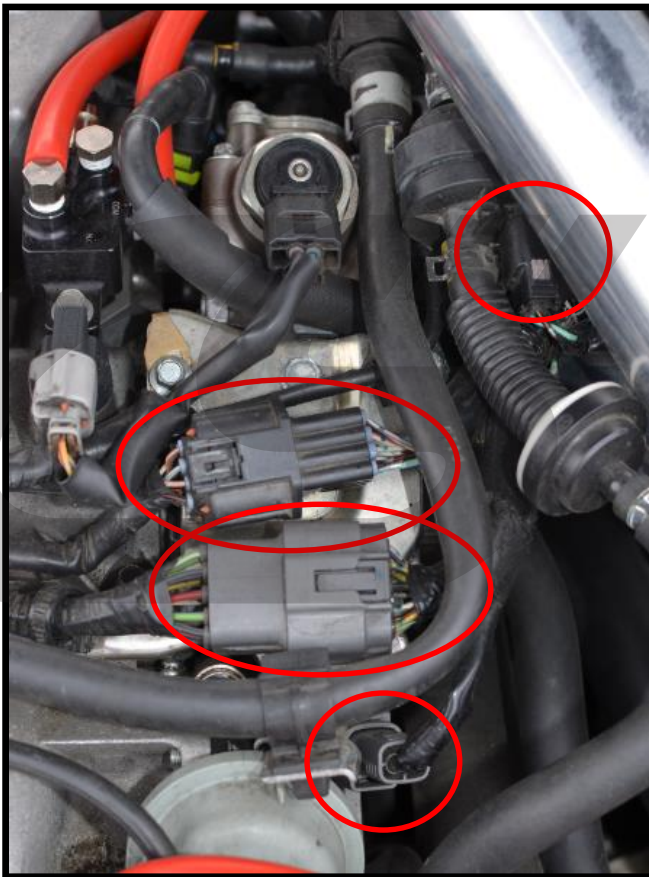

Figure 8c

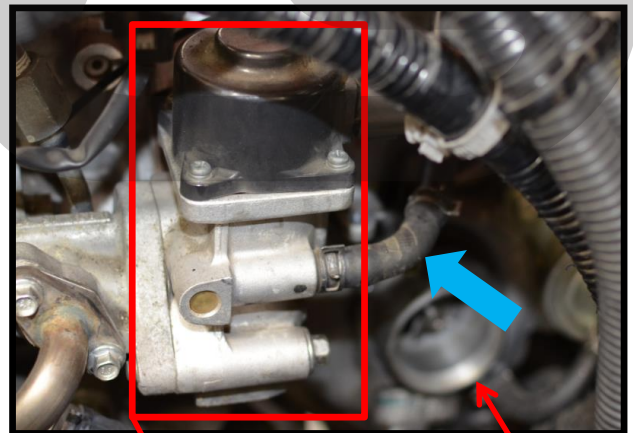

Figure 8d

Turbo

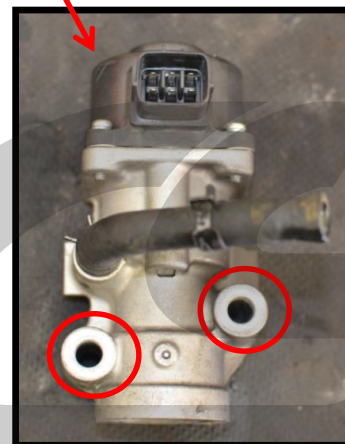

Figure 8e

DETAILED INSTRUCTIONS:

8. Clearing a Path for the Turbocharger (cont.)

- f) The result of clearing a path should look similar to **Figure 8f** below. The turbo can be removed and installed through the opening **circled in red**.



Figure 8f

9. Removing the OEM Turbocharger

- a) Remove the 14mm oil feed banjo bolt, **circled in red** in **Figure 9a**.

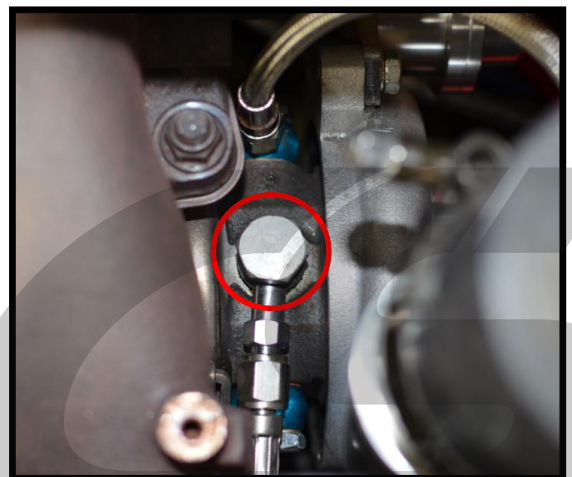

Figure 9a

DETAILED INSTRUCTIONS:

9. Removing the OEM Turbocharger (cont.)

- b) Remove the 12mm flange nut connecting the coolant line brace to the turbo. **Red circle in Figure 9b.**
- c) Remove the four 14mm nuts holding the turbo to the exhaust manifold, **circled in red in Figure 9c.**



Removing the nuts holding the turbocharger to the exhaust manifold will allow the turbo to fall if not held.

- b) Remove the turbo from the vehicle through the opening shown in **Figure 8f** on the previous page.



Figure 9b

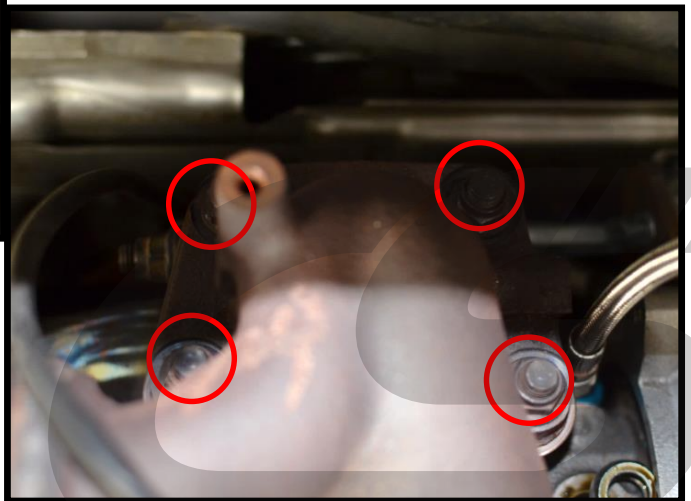

Figure 9c

DETAILED INSTRUCTIONS:



The different wastegates have been broken down into multiple different sections.

For CST4 Internal Wastegate, continue on this page.

For CST4 External Wastegate, continue on page 24.

10. CST4 IWG Setup & Installation

- Remove the 17mm banjo bolt & lower coolant hard line from the OEM turbocharger, shown with the red circle in **Figure 10a**. Install this line on the CS turbocharger with the two new provided M14 copper crush washers. **Torque to 20 ft-lb.**
- Remove the two 8mm bolts holding the turbine heat shield, circled in blue in **Figure 10a**. Install the heat shield on the CS turbocharger. **Torque to 10 ft-lbs.**
- Install the provided upper coolant line with the OEM 17mm banjo bolt and new provided copper crush washers and **Torque to 20 ft-lb.** Shown with the red circle in **Figure 10b**. Install the M6 16mm flange bolt provided. Shown with the green circle in **Figure 10b**. Also shown in **Figure 10c** on next page with a front view of the turbo.

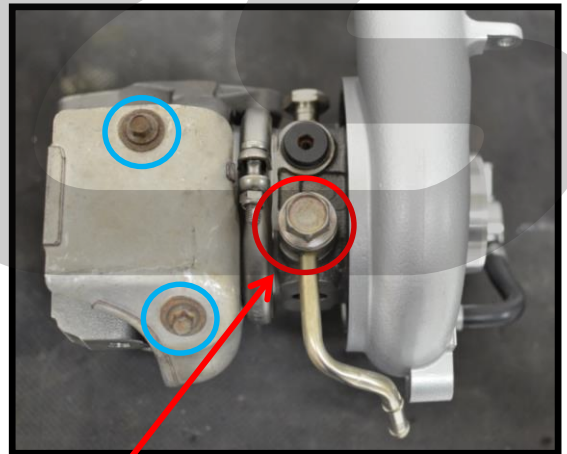

Figure 10a



M14 Copper
Crush Washer



Top Coolant
Line

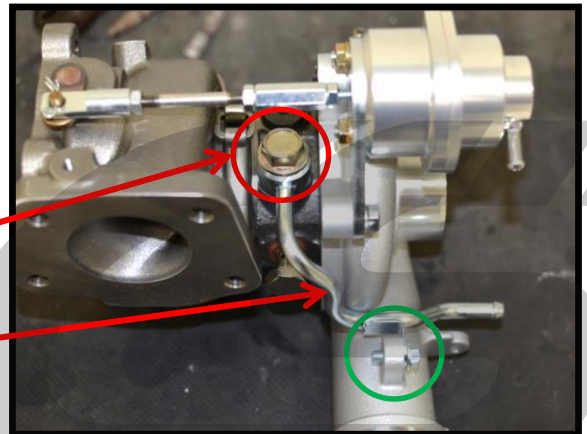

Figure 10b

DETAILED INSTRUCTIONS:

10. CST4 IWG Setup & Installation (cont.)

- d) Boost Control Setup. If you are running an aftermarket Electronic Boost Control Solenoid (EBCS): Read the instructions provided with the EBCS carefully. There is a restrictor pill located in the vacuum line on the compressor that may need to be removed. CorkSport recommends running an "interrupt" (3-port) setup with an aftermarket EBCS if possible. However, all parts have been optimized for OEM "bleed" (2-port) boost control setup.
- e) Apply a small amount of anti-seize coating to the short threaded end of the provided studs as shown in **Figure 10d**.
- f) Install all nine studs into the turbo housing hand tight as shown in **Figure 10e**. Then install the exhaust manifold gasket.
- g) Install the CST4 turbocharger through the opening shown in **Figure 8f**.
- h) Attach the supplied crimp nuts and then tighten the four studs **circled in red** in **Figure 10e** to **45-50 ft-lbs**.

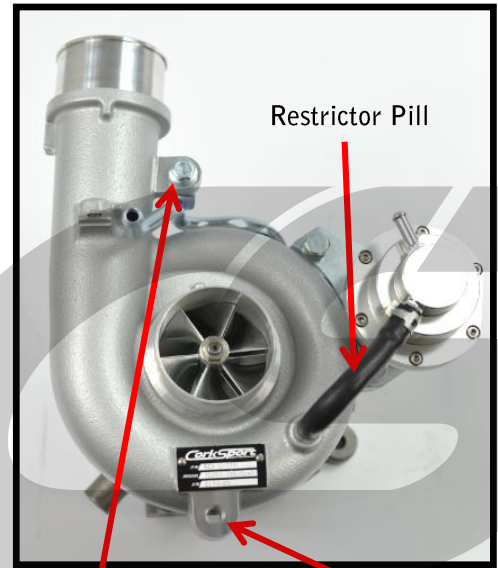

Figure 10c



M6x1.0x12mm
Flange Bolt



M8x1.25x12mm
Flange Bolt

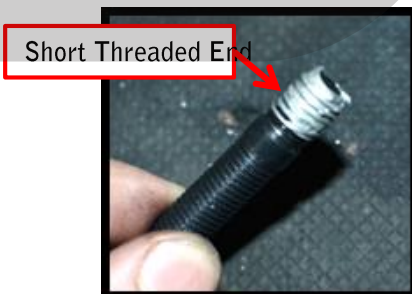

Figure 10d

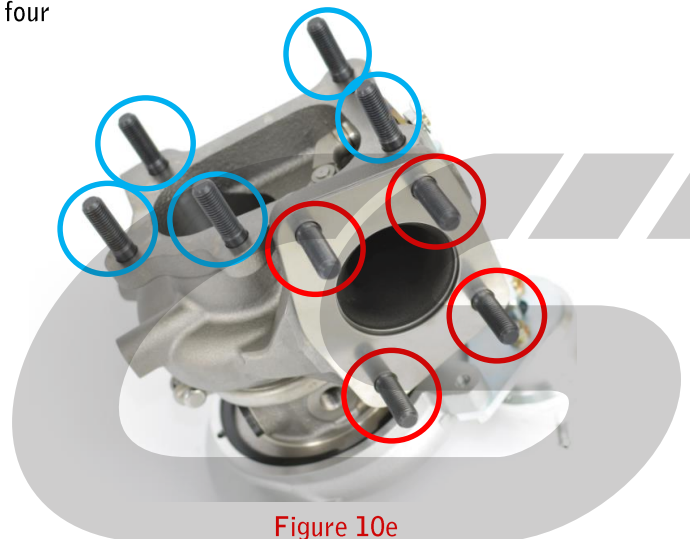
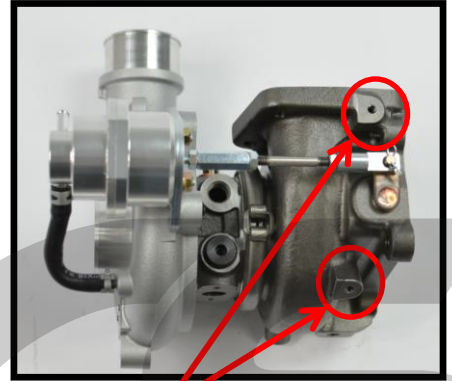
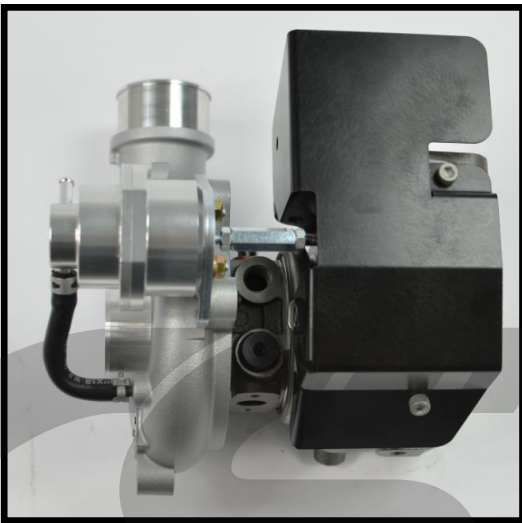

Figure 10e

DETAILED INSTRUCTIONS:

10. CST4 IWG Setup & Installation (cont.)

- i) Once the CST4 is installed in the vehicle, install the provided turbine heat shield.
- j) Use the provided cap screws as shown in **Figure 10f**. Tighten using a 5mm allen wrench/socket.



M6x1.0x10mm
Cap Screws

Figure 10f

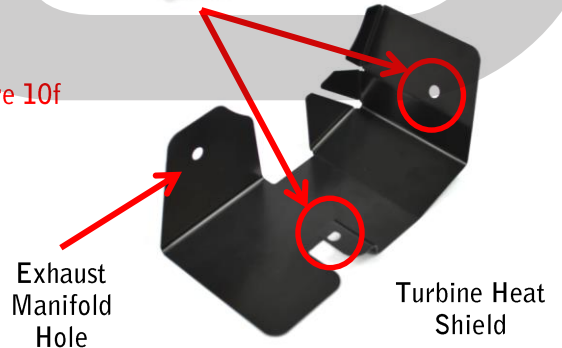

The CorkSport turbocharger is lubricated before the balancing process, but we recommend pouring a small amount of new engine oil or assembly lube into the oil feed port before operating the turbo. This will provide lubrication before initial oil pressure builds. The oil feed port is shown in **Figure 10g** with the **red circle**.

- k) Install the OEM oil feed onto the turbocharger using the supplied banjo bolt and M12 copper crush washers. Tighten to **15ft-lbs.** using a 19mm socket.



Required:
M12x1.25x25mm
Oil Feed Banjo Bolt



M12 Copper
Crush Washer



Figure 10g

DETAILED INSTRUCTIONS:



The different wastegates have been broken down into multiple different sections.

For CST4 Internal Wastegate, continue on page 27.

For CST4 External Wastegate, continue on this page.

11. CST4 EWG Setup & Installation

- a) Remove the 17mm banjo bolt & lower coolant hard line from the OEM turbocharger, shown with the red circle in **Figure 11a**. Install this line on the CS turbocharger with the two new provided M14 copper crush washers. **Torque to 20 ft-lb.**

- b) Install the provided upper coolant line with the OEM 17mm banjo bolt and new provided copper crush washers and **Torque to 20 ft-lb.** Shown with the red circle in **Figure 11b**. Install the M6 10mm flange bolt provided. Shown with the green circle in **Figure 11b**. Also shown in **Figure 11c** on next page with a front view of the turbo.

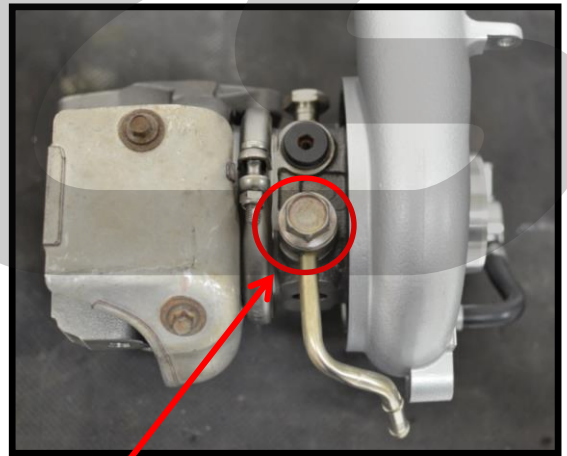
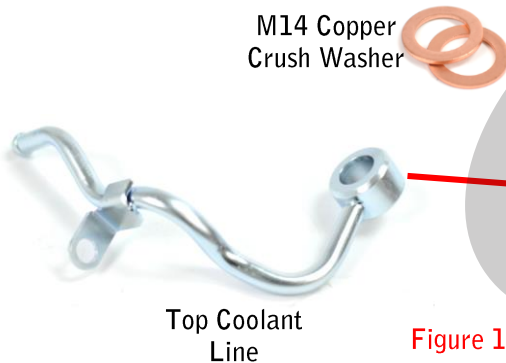

Figure 11a



M14 Copper
Crush Washer



M14 Copper
Crush Washer

Top Coolant
Line

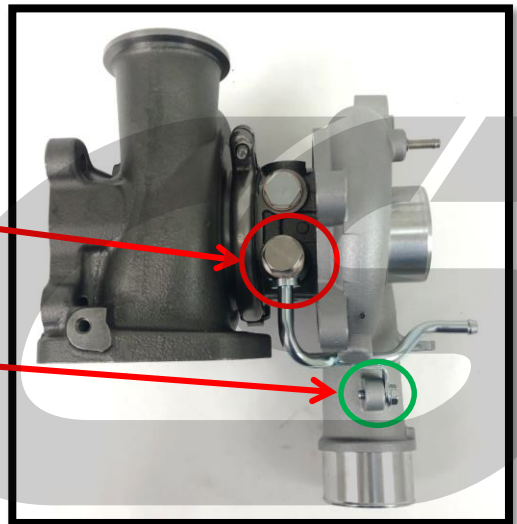

Figure 11b

DETAILED INSTRUCTIONS:

11. CST4 EWG Setup & Installation (cont.)

- c) Apply a small amount of anti-seize coating to the short threaded end of the provided studs as shown in **Figure 11d**.
- d) Install all nine studs into the turbo housing hand tight as shown in **Figure 11e**. Then install the exhaust manifold gasket.
- e) Install the CST4 turbocharger through the opening shown in **Figure 8f**.
- f) Attach the supplied crimp nuts and then tighten the four studs **circled in red** in **Figure 11e** to **45-50 ft-lbs**.

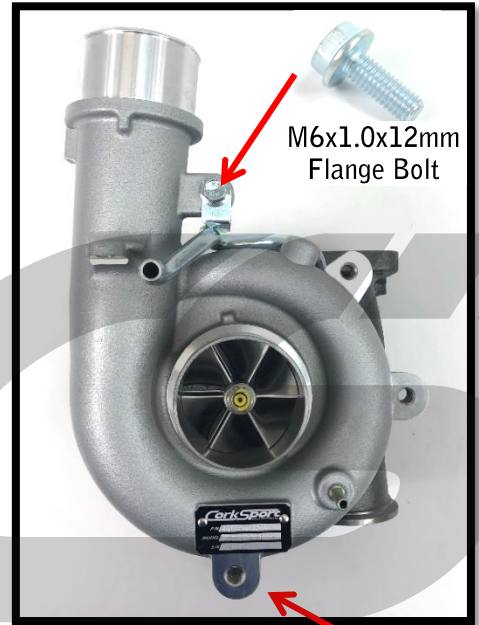

Figure 11c

M8x1.25x12mm
Flange Bolt

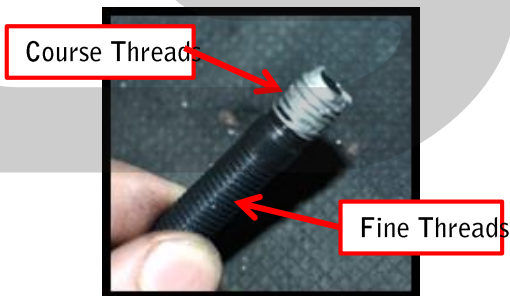

Figure 11d



Figure 11e

DETAILED INSTRUCTIONS:

11. CST4 EWG Setup & Installation (cont.)



The CorkSport turbocharger is lubricated before the balancing process, but we recommend pouring a small amount of new engine oil or assembly lube into the oil feed port before operating the turbo. This will provide lubrication before initial oil pressure builds. The oil feed port is shown in **Figure 11f** with the **red circle**.

- g) Install the OEM oil feed onto the turbocharger using the supplied banjo bolt and M12 copper crush washers. Tighten to **15ft-lbs.** using a 17mm socket.



Required:
M12x1.25x25mm
Oil Feed Banjo Bolt



M12 Copper
Crush Washer

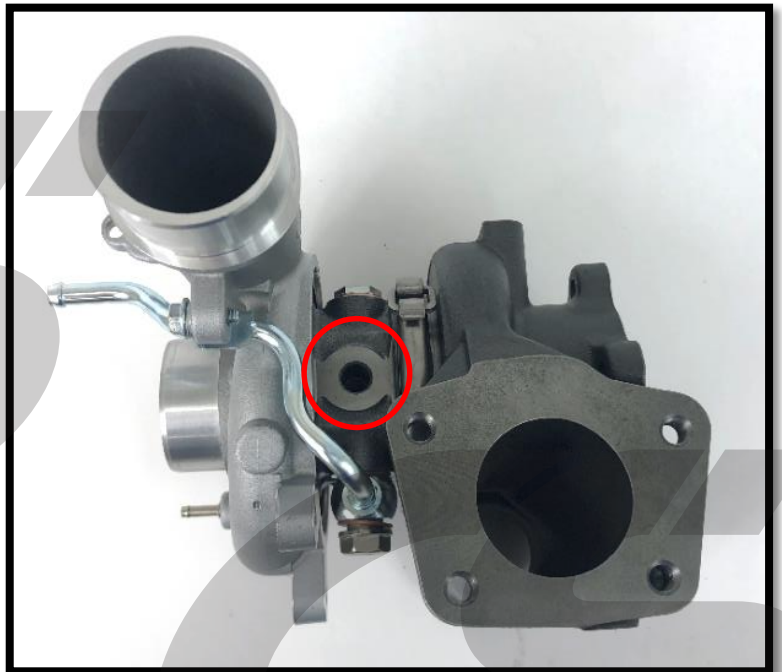

Figure 11f

DETAILED INSTRUCTIONS:



The different wastegates have been broken down into multiple different sections.

For CST4 Internal Wastegate, continue this page.

For CST4 External Wastegate, continue on page 30.

12. CST4 Internal Wastegate Setup



The information below is for use with the OEM electronic boost control solenoid (EBCS). While it can be used, we strongly recommend a CorkSport EBCS for best boost control. For setup with CorkSport EBCS, see the next page.

- a) Reinstall the OEM EBCS onto the mounting location on the compressor housing using the OEM hardware.
- b) Route the two EBCS hoses to the OEM locations & secure with OEM clamps. Routing explained below in [Figure 12a](#) for clarity.

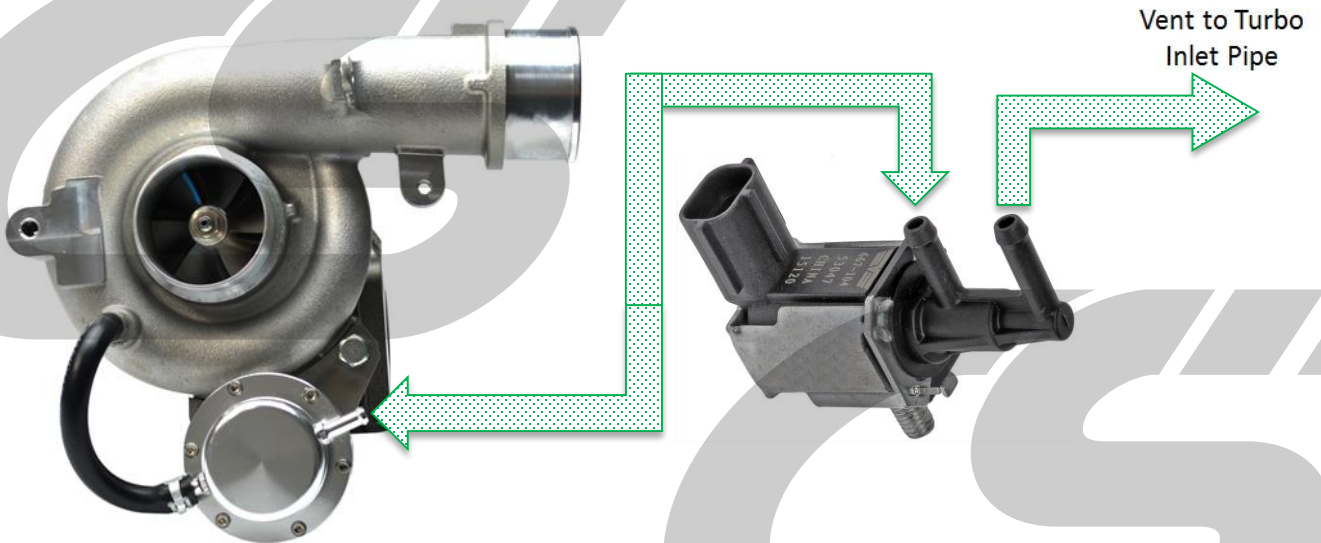

Figure 12a

DETAILED INSTRUCTIONS:

12. CST4 Internal Wastegate Setup (cont.)



The information below and on the next page is for use with a CorkSport EBCS. For setup with other aftermarket EBCS, please see instructions that came with your EBCS.

- c) Install the CorkSport EBCS in your desired location (see the CS EBCS install instructions for full details).
- d) Follow **Figure 12b** below for "bleed" (2-port) setup. This setup is the same as OEM but will not control boost as well as an "interrupt" (3-port) setup.

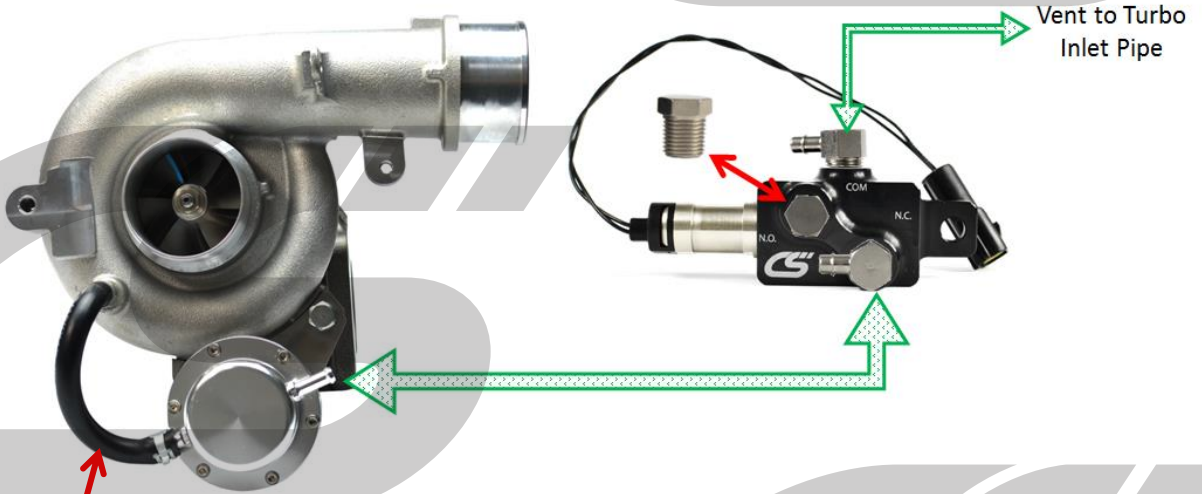

Bleed Setup: Do not remove line w/ restrictor pill. The restrictor pill is required for operation in bleed setup.

Figure 12b

DETAILED INSTRUCTIONS:

12. CST4 Internal Wastegate Setup (cont.)

- e) Follow Figure 12c below for "interrupt" (3-port) setup. This setup is the fastest responding & best setup for an IWG.

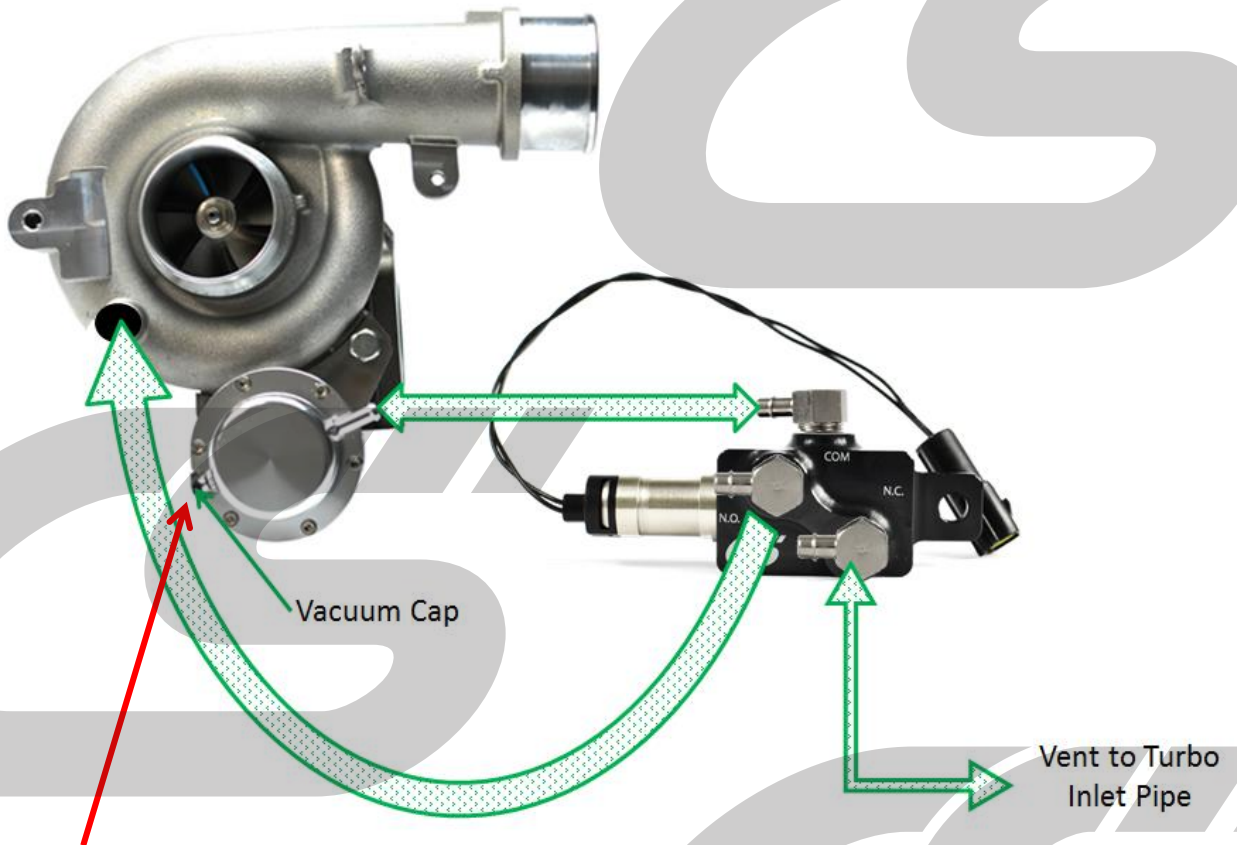

Interrupt Setup: Remove line w/ restrictor pill and place vacuum cap over the exposed port on the wastegate actuator.

Figure 12c

DETAILED INSTRUCTIONS:



The different wastegates have been broken down into multiple different sections.

For CST4 Internal Wastegate, continue on page 33.

For CST4 External Wastegate, continue this page.

13. CST4 External Wastegate Setup



We recommend the Tial MV-R 44mm external wastegate as all CS flanges were sized for this specific EWG.



Ensure you have the valve seat of the EWG installed in the EWG before installing onto the CS elbow. Failure to use this will result in poor boost characteristics. Shown with red arrows in Figure 13a.

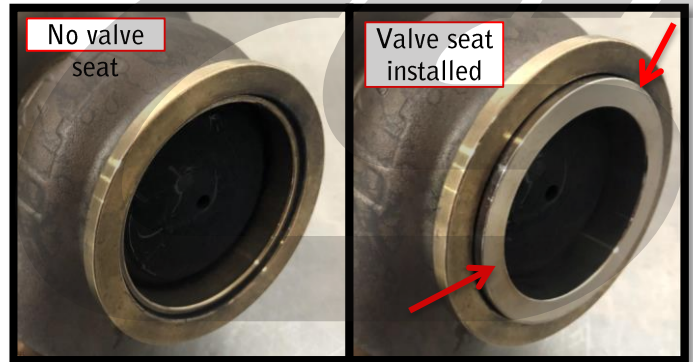

Figure 13a

- a) Install the supplied CorkSport EWG Elbow onto your EWG. Secure using the larger v-band clamp that came with your EWG. Tighten the clamp with a 3/16" Allen wrench and 8mm socket just enough so the components stay connected but are able to rotate freely Shown in Figure 13b.

Before installing the EWG into your vehicle, ensure you have the correct spring(s) installed in your EWG. Talk to your tuner for required spring pressure & see EWG manufacturer's install instructions for correct spring(s) to use to achieve the desired pressure.



Boost pressure will exactly match spring pressure used in EWG. Maximum boost pressure will be approximately 1.8 times the spring pressure chosen.



Figure 13b

DETAILED INSTRUCTIONS:

13. CST4 External Wastegate Setup(continued)



The next few images show the EWG setup on a workbench for clarity.

- b) Attach the CS Elbow loosely on the EWG port of the turbine housing using the supplied CS V-band clamp. Again, tighten the clamp with an 11mm socket just enough so that the components stay connected together, but loose enough that they can still rotate. Shown in **Figure 13c**.



If you purchased the optional CS dumptube, the next step will apply to you. If you did not, you will need to source or fabricate a dumptube.

- c) Attach your CS dumptube loosely onto the outlet of your EWG using the smaller of the two clamps that came with your EWG. Tighten the clamp using an 8mm socket and 5mm Allen wrench just enough to keep the two components connected, but still able to rotate easily. Shown in **Figure 13d**.

- d) Align the parts so that you have good clearances around all components and your dumptube has a clear path out the bottom of the vehicle. You may need to cut a hole in your undertray/skidplate.

- e) Starting at the turbine housing and working your way down the system, tighten the three clamps holding the EWG setup together. Tighten each clamp to **8-12ft-lbs**.

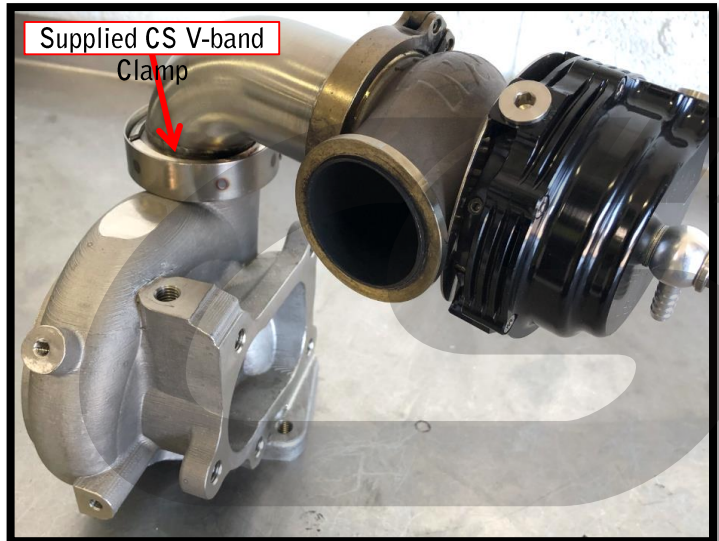

Figure 13c

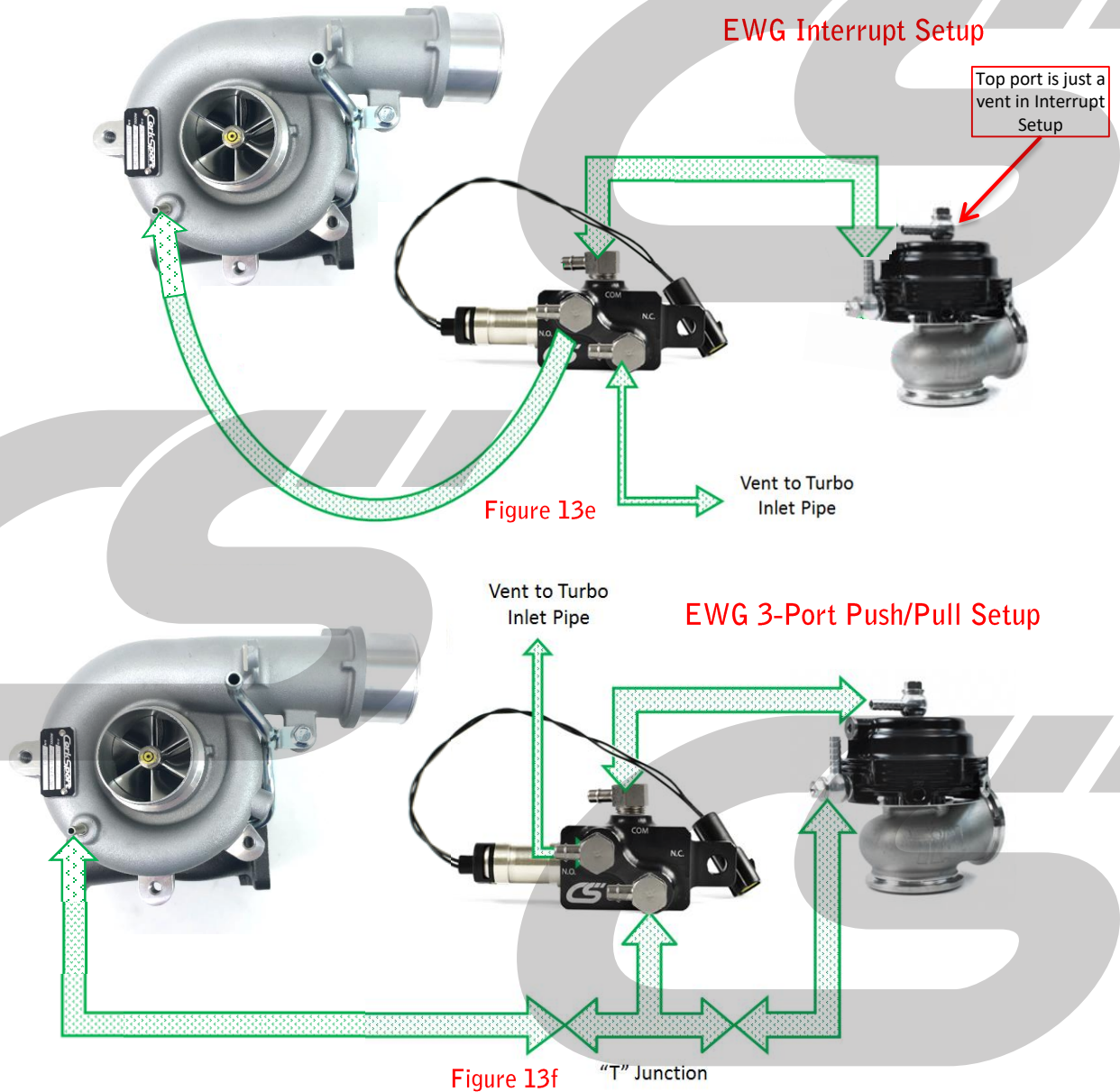

Figure 13d

DETAILED INSTRUCTIONS:

13. CST4 External Wastegate Setup (continued)

- f) See **Figure 13e** and **13f** below for interrupt and push/pull boost control setup respectively. Both setups work well on an EWG setup, so discuss with your tuner what they recommend for your car. If using a Tial MV-R, ensure all air ports not used are plugged.



DETAILED INSTRUCTIONS:

14. Vehicle Reassembly & First Start Up

- a) Follow the instructions in reverse order to complete the vehicle assembly. Refer to torque specs below.
1. Reinstall wiring and EGR removed in Section 8.
 2. Reinstall the lower Turbo Components removed in Section 7. Be sure to top off your engine coolant!



Use the two supplied M6x1.0x12mm bolts for the oil drain line.

3. Reinstall the Downpipe removed in Section 6.
4. Reinstall the Heat shields removed in Section 5.
5. Reinstall the Intercooler removed in Section 4.
6. Reinstall the OEM turbo inlet pipe removed in Section 3.
7. Reinstall the Battery and ECU removed in Section 2.
8. Reinstall the intake and filter removed in Section 1.

b) **Torque Specs:**

- | | | | |
|-----------------|--------------|----------------------|--------------|
| • 8mm Nut/Bolt | 8-10 ft-lbs | • Oil Banjo Bolt | 15 ft-lbs |
| • 10mm Nut/Bolt | 15-17 ft-lbs | • Coolant Banjo Bolt | 20 ft-lbs |
| • 12mm Nut/Bolt | 19-21 ft-lbs | • 17mm Turbine Nuts | 45-50 ft-lbs |
| • 14mm Nut/Bolt | 30-32 ft-lbs | | |



Before starting the vehicle double check that all boost reference lines are routed correctly, airtight, and secure. Failure to do so can result in catastrophic engine failure.



Before starting the vehicle double check all electrical, oil, and coolant connections to ensure they are secure.

- c) Flash your tune for the new turbocharger & wastegate setup.

- d) Start the vehicle. During first startup, watch for any strange noises, leaks, or other issues that may indicate something was installed incorrectly.



**This completes the installation of your CorkSport Turbocharger.
Enjoy the upgraded horsepower & torque.**

WHAT'S NEXT?

CorkSport Camshafts

The CorkSport Performance Camshafts are developed with the latest design, manufacturing, and casting technologies and ground to CNC precision for the best performance for your Mazdaspeed. Near factory idling cams for the daily driver and even the aggressive track driver bringing improvement in throttle response, horsepower, and torque to your Mazdaspeed.



CorkSport 13" Big Brake Kit

The Stage 2 CorkSport 13" Big Brake Kit for Mazdaspeed 3 provides a drastic improvement to braking by offering improvements to each component in the system. Larger rotors, 4-piston calipers, stainless steel brake lines, upgraded pads, and everything you need to install on your Speed 3 is included in this kit. If the CorkSport Big Brake Caliper Kit was not enough for you and your MS3, look no further than the CorkSport 13" BBK.

Also available for Mazdaspeed 6!



CorkSport Front Mount Intercooler Kit

Cool down your boost air temperatures without compromise with the CorkSport Front Mount Intercooler Kit with a small or large intercooler. Featuring all new piping for better fitment and performance, the CorkSport Front Mount Intercooler Kit comes standard with the high flow small core or the optional big core with crash bar. Whether you are sporting a few bolts or a ground breaking big turbo build, this FMIC Kit has the performance to support your goals.



TURBOCHARGER TROUBLESHOOTING GUIDE:

This Turbocharger Diagnostic Tool was created to help understand how to diagnose potential engine and turbo issues. It tells you the possible causes when your engine shows failure symptoms. Often a root engine problem is the cause of the symptom and may result in damaging the turbocharger if not resolved quickly. In these situations, replacing the turbocharger only will not solve the root problem. With this diagnostic tool you can determine the true nature and extent of the issue and resolve the root problem.

BLACK SMOKE:

- EBCS does not raise boost as commanded
- Dirty air filter system
- Dirty compressor or charge air cooler
- Engine air intake leakage post MAF
- Excessive flow resistance in exhaust system/ leakage upstream of turbine
- Foreign object damage (FOD) on compressor or turbine
- Fuel system/injection feed system defective or incorrectly adjusted
- Insufficient oil supply to turbocharger
- Turbine housing/flap damaged
- Turbocharger bearing damage
- Valve guide, piston rings, engine or cylinder liners worn/increased blow by

BLUE/WHITE SMOKE:

- Coke and sludge in turbocharger center housing (CHRA)
- Crankcase ventilation/PCV clogged and distorted
- Dirty air filter system
- Dirty compressor or charge air cooler
- Excessive flow resistance in exhaust system/ leakage upstream of turbine
- Oil feed and drain lines clogged, leaking or distorted
- Piston ring sealing defective
- Turbocharger bearing damage
- Valve guide, piston rings, engine or cylinder liners worn/increased blow by

TURBO CREATES ACOUSTIC NOISE:

- Dirty compressor or charge air cooler
- Engine air leakage of intake and/or charge piping
- Excessive flow resistance in exhaust system/ leakage upstream of turbine
- Exhaust gas leakage between turbine outlet and exhaust pipe

- Foreign object damage on compressor or turbine
- Insufficient oil supply to turbocharger
- Turbine housing/flap damaged
- Turbocharger bearing damage

BOOST PRESSURE TOO HIGH:

EBCS not commanding correct boost pressure and/or missing boost/vacuum line

Fuel system/injection feed system defective or incorrectly adjusted

Insufficient/blocked flow through wastegate

COMPRESSOR/TURBINE WHEEL DEFECTIVE:

Foreign object ingestion of compressor or turbine

Insufficient oil supply of turbocharger

Turbine housing/flap damaged

Turbocharger bearing damage

OIL LEAKAGE AT TURBINE:

Coke and sludge in turbo center housing (CHRA)

Crankcase ventilation/PCV clogged and distorted

Oil feed and drain lines clogged, leaking or distorted

Piston ring sealing defective

Turbocharger bearing damage

Valve guide, piston rings, engine or cylinder liners worn/increased blow by

OIL LEAKAGE AT COMPRESSOR:

Coke and sludge in turbo center housing (CHRA)

Crankcase ventilation/PCV clogged and distorted

Dirty/Restricted air filter system

Excessive flow resistance in exhaust system/leakage upstream of turbine

Oil feed and drain lines clogged, leaking or distorted

Piston ring sealing defective

Turbocharger bearing damage

Valve guide, piston rings, engine or cylinder liners worn/increased blow by

HIGH OIL CONSUMPTION:

Coke and sludge in turbocharger center housing

Crankcase ventilation clogged and distorted

Dirty air filter system

Dirty compressor or charge air cooler

Excessive flow resistance in exhaust system/leakage upstream of turbine

Oil feed and drain lines clogged, leaking or distorted

Piston ring sealing defective

Turbocharger bearing damage

Valve guide, piston rings, engine or cylinder liners worn/increased blow by

INSUFFICIENT POWER/BOOST:

EBCS not commanding correct boost pressure and/or missing boost/vacuum line

Dirty air filter system

Dirty compressor or charge air cooler

Engine air leakage of intake and/or charge piping

Excessive flow resistance in exhaust system/
leakage upstream of turbine

Fuel system/injection feed system defective or
incorrectly adjusted

Foreign object damage on compressor or turbine

Insufficient oil supply to turbocharger

Pipe assy. to swing valve/poppet valve defective

Suction and pressure line distorted or leaking

Turbine housing/flap damaged

Turbocharger bearing damage

Valve guide, piston rings, engine or cylinder liners
worn/increased blow by

RECOMMENDATIONS FOR SERVICE & CARE

GOOD TURBO MAINTENANCE:

Turbochargers are designed to last the life of an engine when operated at modest power ranges for the turbo's capability. A shorter (but still long) life can be expected if the turbo is pushed to its working limits.

To ensure the turbocharger lives a long and potent life, follow routine maintenance with quality fluids.

Oil change intervals

Oil filter system maintenance

Oil pressure control

Air filter system maintenance

BAD FOR A TURBOCHARGER:

90 % of all turbocharger failures are due to the following causes:

These failures can be avoided by regular maintenance of the engine and engine subsystems that affect the turbocharger.

Blocked/Closed BPV/BOV Port

Penetration of foreign objects into the turbine or the compressor

Dirt/metal/non-oil fluids in the oil supply

Inadequate oil supply (oil pressure/filter system/restricted oil drain)

High exhaust gas temperatures (ignition system/injection system)

We hope this Turbocharger Diagnostic Tool is helpful to you and your build! When modifying cars there are always many variables to consider, we aimed to provide this troubleshooting tool so you can quickly and accurately diagnose your car and get it back on the road for you to enjoy.

Please shoot us an email or call for any support!